



China Patent No.: ZL02220153.X,
ZL02257746.7

Multi-functional Flow Control Valve for Water Treatment Systems

53502 (Old Model No.:F71B1)
53502B (Old Model No.:F71G1)
53504 (Old Model No.:F67C1)
53504B (Old Model No.:F67G1)
53510 (Old Model No.:F75A1)
53510B (Old Model No.:F75B1)

Instruction Manual



Please read this manual in details
before using this valve and keep it properly
in order to consult in the future

0WRX.466.508

MODEL: F71B/F71G/F67C/F67G/F75A/F75B

Before the valve put into use, please fill in the below content so as to help us to refer in the future.

Filter System Configuration

Tank size: Dia. _____ mm, Height _____ mm;
Refilled filter materials _____ Kg; Granularity of filter materials _____ mm;
Control valve model _____; Number _____;
Pressure of inlet water _____ Mpa; Turbidity of inlet water _____ FTU.
Water source: Ground-water ; Filtered ground-water ;
Tap water ; Other _____.

Parameter Set

Parameter	Unit	Factory Default	Actual Value
Service Days(Time clock type, by days)	D.	03	
Service Hours(Time clock type, by hours)	H.	20	
Rinsing Time	/	02:00	
Rinsing Frequence	/	F-00	
Backwash Time	Min.	10	
Fast Rinse Time	Min.	10	
Output Mode b-01(02)	/	b-01	

Catalogue

Notice.....	3
1. Product Overview.....	4
1.1. Main Application & Applicability.....	4
1.2. Product Characteristics.....	4
1.3. Service Condition.....	6
1.4. Product Structure and Technical Parameters.....	6
1.5. Installation.....	8
2. Basic Setting & Usage.....	10
2.1. The Function of PC Board.....	10
2.2. Basic Setting & Usage.....	12
3. Applications.....	14
3.1. Filter Flow Chart.....	15
3.2. The Function and Connection of PC Board.....	16
A. Signal Output Connector.....	17
B. Interlock.....	20
C. Pressure Relief Output.....	21
D. Remote Handling Connector.....	21
3.3. System Configuration and Flow Rate Curve.....	22
3.4. Parameter Enquiry and Setting.....	24
3.5. Trial Running	26
3.6. Trouble-Shooting.....	27
3.7. Assembly & Parts.....	30
4. Warranty Card.....	43

Notice

- To ensure normal operation of the valve, please consult with professional installation or repairing personnel before use it.
- If there are any of pipeline engineering and electric works, there must be finished by professional at the time of installation.
- Do not use the control valve with the water that is unsafe or unknown quality.
- Depending on the changing of working environment and water requirement, each parameter of filter should be adjusted accordingly.
- Test water periodically to verify that system is performing satisfactorily.
- Do not put the valve near the hot resource, high humidity, corrosive, intense magnetic field or intense vibrations environment. And do not leave it outside.
- Forbidden to use the drain pipeline or other connectors as support to carry the system.
- Please use this product under the water temperature between 5~50°C, water pressure 0.15~0.6MPa. Failure to use this product under such conditions voids the warranty.
- If the water pressure exceeds 0.6Mpa, a pressure reducing valve must be installed before the water inlet. While, if the water pressure under 0.15MPa, a booster pump must be installed before the water inlet.
- Do not let children touch or play, because carelessness operations may cause the procedure changed.
- When the attached cables of this product and transformer are changed, they must be changed to the one that is from our factory.
- For 53510(F75A) and 53510B(F75B1) product, in order to dismantle easily, it is suggested to install the strainer with M88 × 2 male thread.

1. Product Overview

1.1. Main Application & Applicability

Used for filtering water treatment systems

Be suitable for Residential filtering system

Swimming pool filtering equipment (F75A1/53510、 F75B1/53510B)

Carbon filter or sand filter in RO pretreatment filtering system

1.2. Product Characteristics

➤Simple structure and reliable sealing

It adopts hermetic head faces with high degree pottery and corrosion resistance for opening and closing. It combines with Service, Backwash, and Fast Rinse.

➤No water pass the valve in rinsing in single tank type

➤Manual function

Realize rinsing immediately by pressing  at any time.



➤Long outage indicator

If outage overrides 3days, the time of day indicator  will flash to remind people to reset new time of day. The other set parameters do not need to reset. The process will continue to work after power on.

➤LED dynamic screen display

The stripe on dynamic screen flash, it indicates the control valve is in service; otherwise, it is in rinsing cycle.

➤Buttons lock

No operations to buttons on the controller within 1 minute, button lock indicator light on which represent buttons are locked. Before operation, press and hold the  and  buttons for 5 seconds to unlock. This function can avoid incorrect operation.

➤Rinsing frequency

It could set up multiple risings, which means several times of backwash and fast rinse but one time of service. It is much better for cleaning the filter materials.(Refer to P25 for more details.)

➤There are two kinds of time clock types

Time clock type valve can be chosen to be service by hours ,by dialing the red switch on main control board to “1” (Refer to the Figure 3-1). Pointing to “ON” mean the time clock type service by days; “1” means the time clock type service by hours.

(Attention: after dialing the switch, please restart the power)

MODEL: F71B/F71G/F67C/F67G/F75A/F75B

➤Interlock function

It has a function of interlock to realize only one valve in rinsing, but the other valves are in service while there are several valves parallel in system. In multi-steps treatment systems such as RO pre-treatment, when several valves are in series, there is only one valve in rinsing to ensure pass water all the times while different valves in rinsing. (Application refer to Figure 3-10)

➤Signal output

There is a signal output connector on main control board. It is for controlling external wiring(Refer to Figure, from Figure3-2 to Figure 3-9).

There are two kinds of output modes. b-01 Mode: Turn on start of regeneration and shut off end of regeneration; b-02 Mode: Signal available only intervals of rinsing cycles and in service.

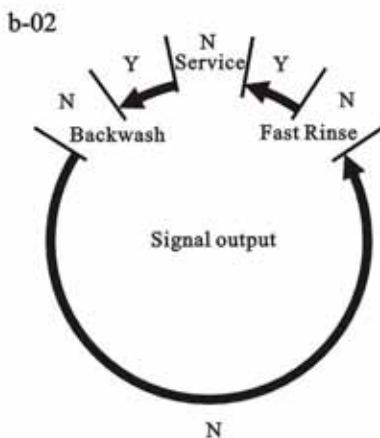
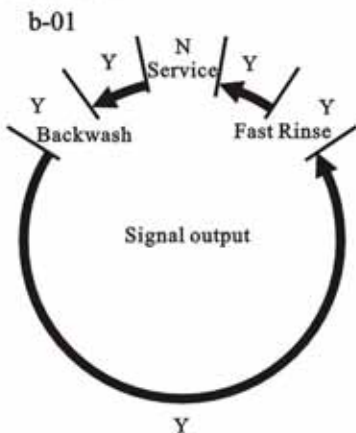

➤Remote handling input

This connector can receive external signal, used together with PLC, and computer etc. to control the valve. (Application refer to Figure3-12)

➤Pressure relief output

The valve will cut off feeding water to drain line when it switches in rinsing cycles (Same as signal output b-02). Thus in some water treatment system, e.g. Deep Well, one booster pump was installed on the inlet to increase the system water feeding pressure, this cut-off will cause pressure on inlet rising too fast to damage the valve. Pressure Relief Output can be used to avoid this problem. (Application refer to Figure3-11).

➤All parameters can be modified

According to the water quality and usage, the parameters in the process can be adjusted.

MODEL: F71B/F71G/F67C/F67G/F75A/F75B

1.3. Service Condition

Filter Valve should be used under the below conditions:

Items		Requirement
Working conditions	Water pressure	0.15MPa ~ 0.6MPa
	Water temperature	5°C ~ 50°C
Working environment	Environment temperature	5°C ~ 50°C
	Relative humidity	≤95% (25°C)
	Electrical Facility	AC100 ~ 240V/50 ~ 60Hz
Inlet water quality	Water turbidity	<20FTU

Note: The parameter in the above chart is only suitable for the filter matched with our filter valves.

When the water turbidity exceeds the conditions, the impurity in the inlet water should be coagulated and precipitated firstly.

1.4. Product Structure and Technical Parameters

Dimension(The appearance is just for reference. It is subjected to the real product)

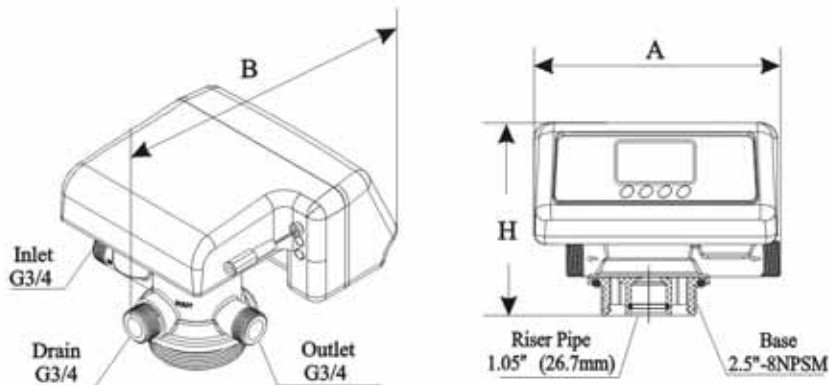

Model	A(mm) max	B(mm) max	H(mm) max	Transformer Output	Flow Rate m ³ /h @0.3MPa
F71B (53502)	182.5	195.5	143	DC12V、1.5A	2.0
F71G (53502B)	199	180	167		

MODEL: F71B/F71G/F67C/F67G/F75A/F75B

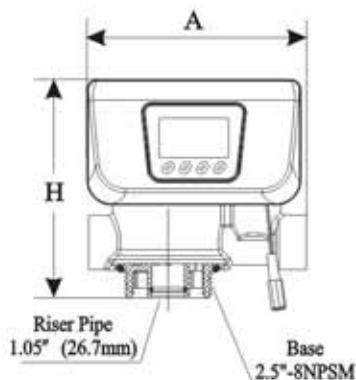
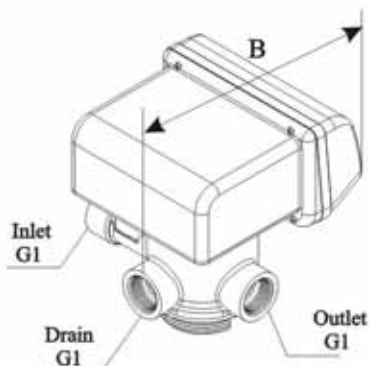

Model	A(mm) max	B(mm) max	H(mm) max	Transformer Output	Flow Rate m ³ /h @0.3MPa
F67B (53504)	180	194	178.5	DC12V、1.5A	4.0
F67G (53504B)	242	204	198		

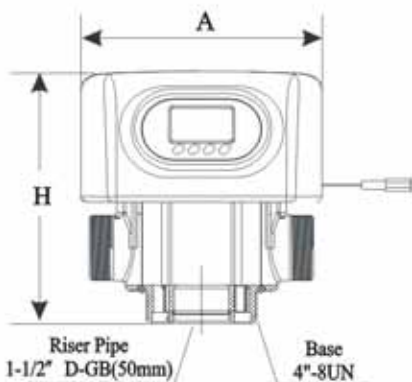
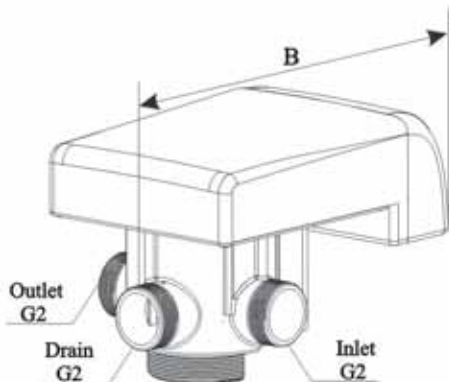

Model	A(mm) max	B(mm) max	H(mm) max	Transformer Output	Flow Rate m ³ /h @0.3MPa
F75A (53510)	220	346.5	230.5	DC24V、1.5A	10.0
F75B (53510B)	216.5	346.5	247		

MODEL: F71B/F71G/F67C/F67G/F75A/F75B

1.5. Installation

A. Installation notice

Before installation, read all those instructions completely. Then obtain all materials and tools needed for installation.

The installation of product, pipes and circuits, should be accomplished by professional to ensure the product can operate normally.

Perform installation according to the relative pipeline regulations and the specification of Water Inlet, Water Outlet, and Drain Outlet.

B. Device location

- ① The filter should be located closely to drain.
- ② Ensure the unit is installed in enough space for operating and maintenance.
- ③ The unit should be kept away the heater, and exposed outdoor. Sunshine or rain will cause the system damage.
- ④ Please avoid to install the system in one Acid/Alkaline, Magnetic or strong vibration circumstance, because above factors will cause the system disorder.
- ⑤ Do not install the filter, drain pipeline in circumstance which temperature may drop below 5°C, or above 50°C.
- ⑥ One place is recommended to install the system which causes the minimum loss in case of water leaking.

C. Pipeline connection (Taking F71B for example)

① Install control valve

a. As the Figure 1-1 shows, select the relevant riser pipe, glue the riser pipe to the bottom strainer and put it into the mineral tank, cut off the exceeding tube out of tank top opening. Plug the riser tube in case of mineral entering.

b. Fill the mineral to the tank, and the height is accordance with the design code.

c. Remove the tap covering on the central tube and check if the riser tube is on the central of tank.

d. Install the top distributor to the valve and insert the riser tube into control valve and screw tight control valve.



Figure 1-1

MODEL: F71B/F71G/F67C/F67G/F75A/F75B

Note:

- The length of riser tube should be neither higher 1mm nor lower 5mm tank top opening height, and its top end should be rounded to avoid damage of O-ring inside the valve.
- Avoid floccules substance together with filter materials fill in the tank.
- Avoid O-ring inside control valve falling out while rotating it on the tank.

② Pipeline connection

- As figure 1-2 shows, install a pressure gauge in water inlet.
- Install valve A, valve B, valve C and valve D in the inlet and outlet pipeline. The valve D is sampling valve.
- Install the check valve in the outlet pipeline.
- Inlet pipeline should be in parallel with outlet pipeline. Support inlet and outlet pipeline with fixed holder.

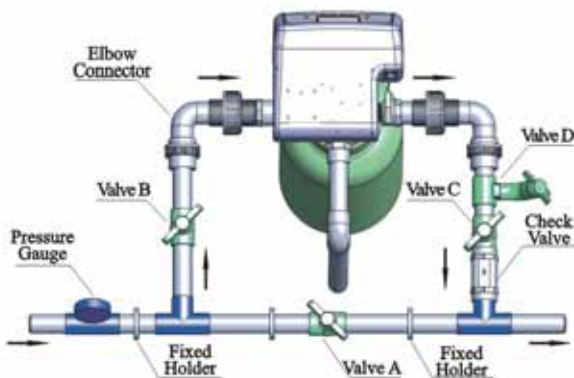

Figure1-2

Note:

- If making a soldered copper installation, do all sweat soldering before connecting pipes to the valve. Torch heat will damage plastic parts.
- When turning threaded pipe fittings onto plastic fitting, use care not to cross thread or broken valve.

MODEL: F71B/F71G/F67C/F67G/F75A/F75B

③ Install drain pipeline

Directly connect the outlet with the rigid pipeline, such as UPVC, etc.

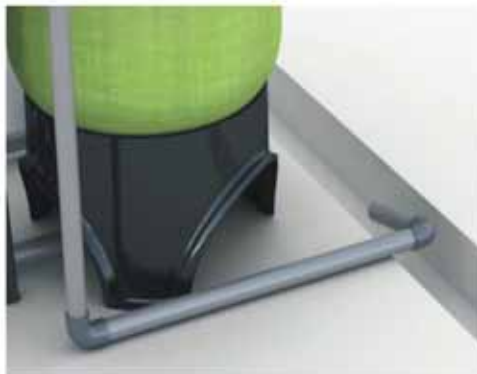

Figure 1-3

Note:

- Control valve should be higher than drain outlet, and be better not far from the drain hose.
- Be sure not connect drain with sewer, and leave a certain space between them (As the figure 1-3 shows), avoid wastewater be absorbing to the water treatment equipment.
- If wastewater is used for other purpose. Please use another container for loading. And also keep a certain space between drain and container.

2. Basic Setting & Usage

2.1. The Function of PC Board

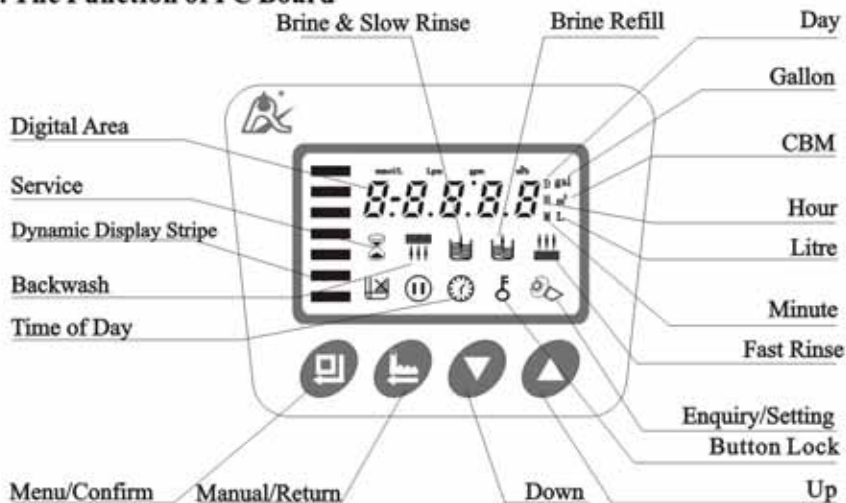





MODEL: F71B/F71G/F67C/F67G/F75A/F75B







A. Time of day indicator

-  Light on, display the time of day.









B. Button lock indicator

-  Light on, indicate the buttons are locked. At this moment, press any single button will not work (No operation in one minute,  will light on and lock the buttons.)
- Solution: Press and hold both  and  for 5 seconds until the  light off.







C. Program mode indicator

-  Light on, enter program display mode. Use  or  to view all values.
-  Flash and enter program set mode. Press  or  to adjust values.







D. Manu/Confirm button

- Press ,  light on, enter program display mode and use  or  to view all values.
- In program display mode, press ,  flash, enter program set mode, press  or  and adjust values.
- Press  after all program are set, and then the voice “Di” means all setting are success and return program display mode.

E. Manual/Return button

- Press  in working conditions, it can proceed to next step. (Example: when the outlet water fails to reach the requirement, you can press  to end the service and start an immediate rising. During the process of rising, pressing the  button can end one step in advance and proceed to the next step.)
- Press  in program display mode, and it will return in Service. Press  in program set mode, and it will return program display mode.
- Press  while adjusting the value, then it will return program display mode directly without saving value.





F. Down and Up

- In program display mode, press  or  to view all values.
- In program set mode, press  or  to adjust values.
- Press and hold both  and  for 5 seconds to lift the Button Lock status.

MODEL: F71B/F71G/F67C/F67G/F75A/F75B

2.2. Basic Setting & Usage

A. Parameter specification

Function	Indicator	Factory Default	Parameter Set Range	Instruction
Time of Day		Random	00: 00~23:59	Set the time of day when use, “: ” flash
Service Days		1-03D.	0~99Days	Only for Time Clock Type, by days
Service Hours		1-20H.	0~99 Hours	Only for Time Clock Type, by hours
Rinsing Time	02:00	02:00	00: 00 ~ 23:59	Rinsing time; “: ” light on
Rising Frequency	F-00	00	0 ~ 20	Rising frequency. For example, F-01: indicate service 1 time, backwash and fast rinse 2 time;
Backwash Time		10Min.	0 ~ 99:59	Backwash time(Minute), correct to second;
Fast Rinse Time		10Min.	0 ~ 99:59	Fast Rinse Time(Minute), correct to second;
Output Control Mode	b-01	01	01 or 02	Mode 01: Signal turn on start of rinsing and shut off end of rinsing. (Refer to the figure on P5) Mode 02: Signal available only intervals of rinsing cycles and in service. (Refer to the figure on P5)

MODEL: F71B/F71G/F67C/F67G/F75A/F75B

B.Process Display (Time Clock Type, by days)



Working status	The circular interface displays in turn		
Service			
Backwash			
Fast Rinse			

Illustration:

- The display screen will only show “-00-” when the electrical motor is running.
- The time of day figure  flash continuously, such as “12: 12” flash, indicates long outage of power. It reminds to reset the time of day.
- The display will show the error code, such as “-E1-” when the system is in error.
- Working process: Service → Backwash → Fast Rinse

3. Applications

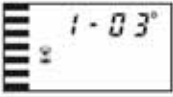
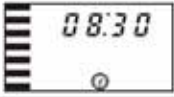
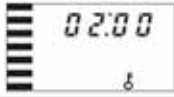
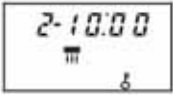
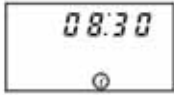
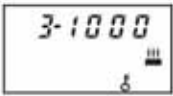
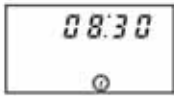
3.1. Filter Flow Chart

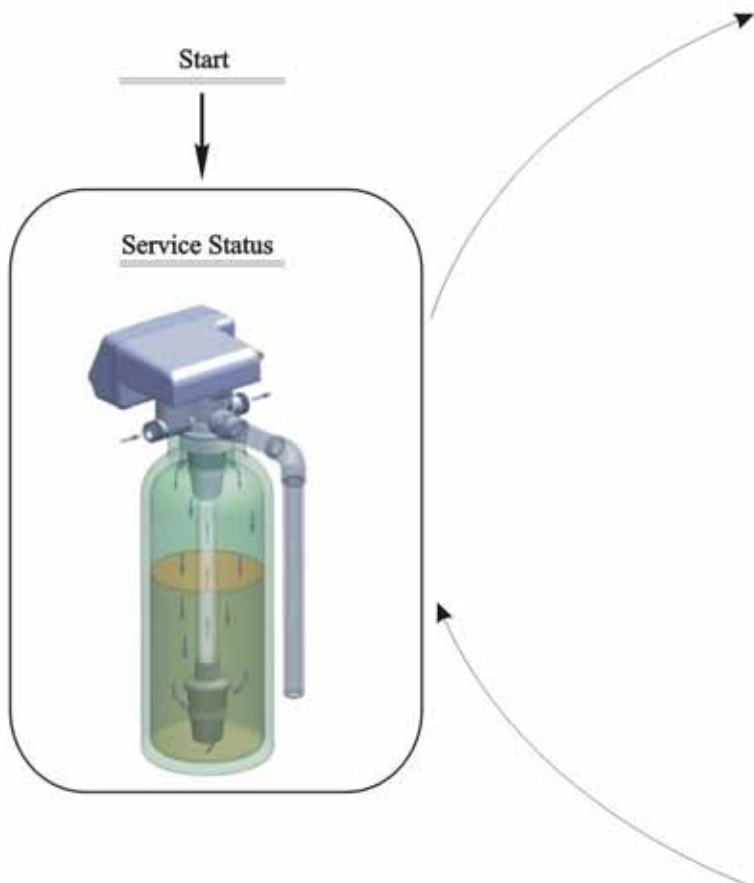

MODEL: F71B/F71G/F67C/F67G/F75A/F75B

Backwash Status



Fast Rinse Status



MODEL: F71B/F71G/F67C/F67G/F75A/F75B

3.2. The Function and Connection of PC Board

Opening the front cover of control valve, you will see the main control board and connection port as Figure 3-1A shows (For F71, F67)

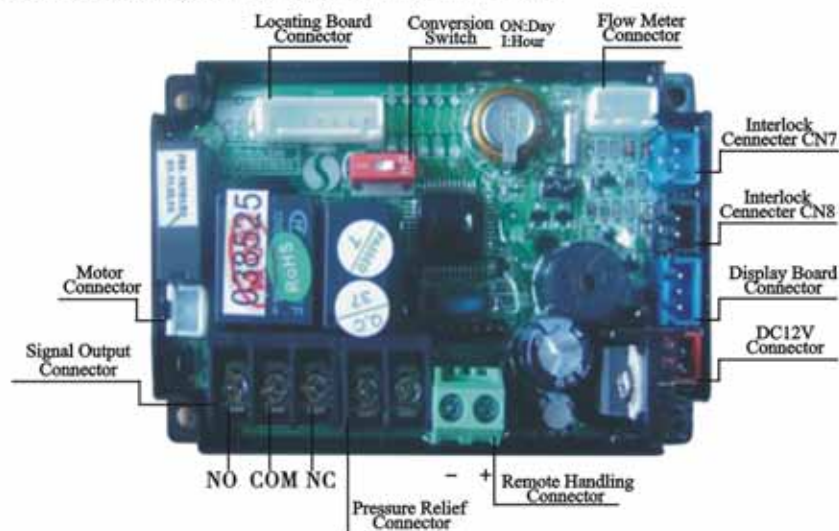

Figure 3-1A

F75 main control board and connection port as Figure3-1B shows

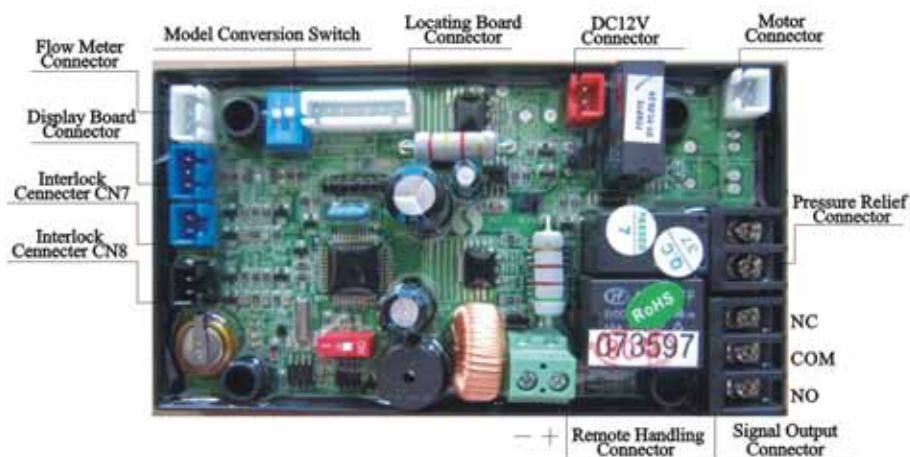

Figure 3-1B

MODEL: F71B/F71G/F67C/F67G/F75A/F75B

The main functions on main control board:

Function	Application	Explanation
Signal output connector b-01	Outlet solenoid valve	If system strictly require no hard water flow from outlet or controlling the liquid level in water tank.
	Inlet pump	Increase pressure for regeneration or rinsing. Use the liquid level controller to control inlet pump to ensure there is water in tank.
Signal output connector b-02	Inlet solenoid valve or inlet pump	When inlet pressure is high, it needs to close water inlet when valve is rotating to protect motor.
Pressure relief connector	Control the inlet by-pass to release pressure	When valve is rotating, pressure relief connector opened to prevent pressure increasing rapidly.
Interlock connector	To ensure only one control valve regeneration or rinsing in system.	Use in RO Pre-treatment, water supply together but regeneration in turn, second grade ion exchange equipment, etc.
Remote handling connector	Receipt signal to make the control rotate to next circle	It is used for on-line inspection system, PC connection, and realize automatically or remote controlling valve.

A. Signal Output Connector

1) Control Solenoid Valve (Set b-01)

① Solenoid valve on outlet controls water level in brine tank.

Instruction: If system strictly requires no unfiltered water flow from outlet in rinsing cycle (Mainly for no unfiltered water flow out when valve is switching. When valve in backwash positions, there is no unfiltered water flow from outlet), a solenoid valve could be installed on outlet, the wiring refer to Figure 3-2.

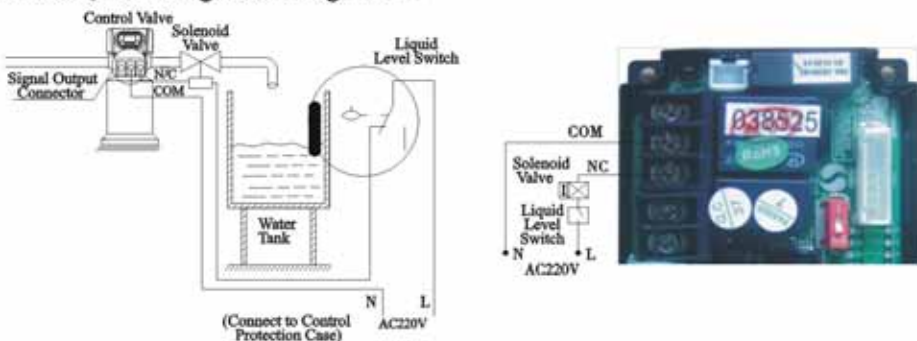

Figure 3-2 Wring of Solenoid Valve on Outlet

MODEL: F71B/F71G/F67C/F67G/F75A/F75B

Function:

In service status, if water tank is short of water, solenoid valve is open to supply filtered water. But if water tank has enough water, solenoid valve is closed, so no filtered water supplied.

When the valve is in backwash status, there is no signal output. So, solenoid valve is closed, and no unfiltered water flow into the tank.

②Solenoid valve on inlet(Set b-02)

Instruction: When inlet pressure exceeds 0.6MPa, connect a solenoid valve on inlet in series. Control mode is b-02. Solenoid valve closed when valve switching, the wiring refer to Figure 3-3. As Figure 3-4 shows, it also can use the pressure relief port to connect a solenoid valve on inlet in series.

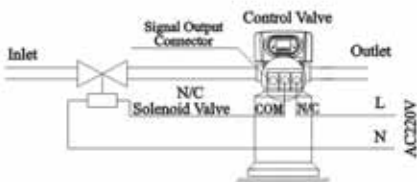

Figure 3-3 Wiring of Solenoid Valve on Inlet

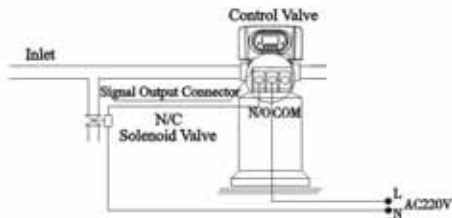

Figure 3-4 Wiring of Pressure Relief Port

Function:

When inlet pressure is high, install a solenoid valve on inlet to ensure valve switching properly. When valve is exactly at position of Service, Backwash, and Fast Rinse, solenoid valve is open. When valve is switching, solenoid valve is closed, no water flow into valve to ensure valve switching properly. It could prevent the problem of mix water and water hammer.

Use interlock cable to realize valves in parallel and series in same system which is suited for RO pretreatment system or second grade Na^+ system. The Wiring refer to Figure 3-5:

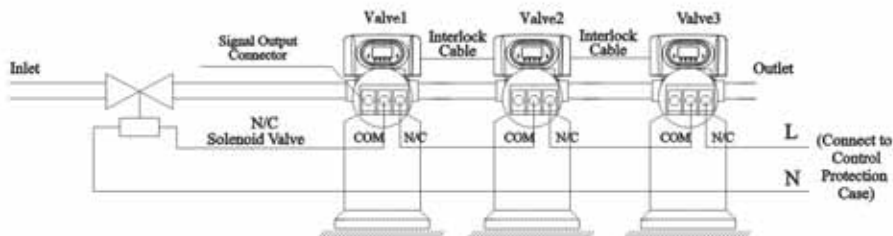

Figure 3-5 Wiring of Solenoid Valve on Inlet for Valve in Parallel and Series

MODEL: F71B/F71G/F67C/F67G/F75A/F75B

2) Liquid Level Controller controls Inlet Pump(Two-phase motor)(Set b-01)

Instruction: For the system using well or middle-tank supplying water, use switch of liquid level controller and valve together to control pump opening or closing. The wiring refer to Figure 3-6

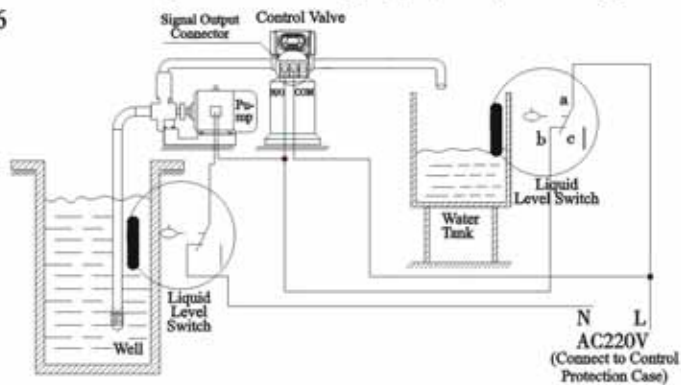

Figure 3-6 Wiring of Liquid Level Controller Controlling 220V Inlet Pump

Function:

When valve in service status, if water tank is short of water, start up pump, but if water tank has enough water, the switch of liquid level controller is closed, so pump doesn't work.

When valve in generation status like backwash, inlet always has water no matter what is water condition in water tank. As Runxin valve no water pass outlet in regeneration cycle, it ensures no water fill into brine tank.

A liquid level switch at well mouth or in middle water tank in RO system protects pump from working without water in case of out of raw water.

3) Liquid Level Switch in Water Tank Controls Inlet pump (Three-phase) (Set b-01)

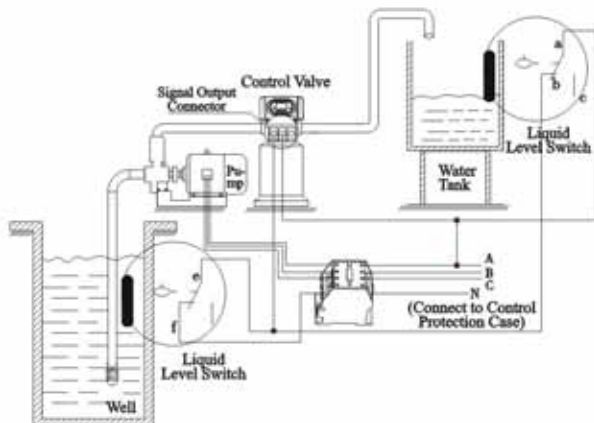

Figure 3-7 Wiring of Liquid Level Switch in Water Tank Controls 380V Inlet Pump

MODEL: F71B/F71G/F67C/F67G/F75A/F75B

The principle is the same as for two-phase's, only change single-phase pump into three-phase motor, and use an AC contactor(Refer to Figure 3-7)

4) Control Inlet Booster Pump(Set b-01)

Instruction: If inlet water pressure is less than 0.15MPa, which makes backwashing and drawing difficult, a booster pump is suggested to be installed on inlet. Control mode b-01. When system in regeneration cycle, booster pump is open, the wiring refer to Figure 3-8.If the booster pump current is bigger than 5A, system need to install an contactor, the wiring refer to Figure3-9

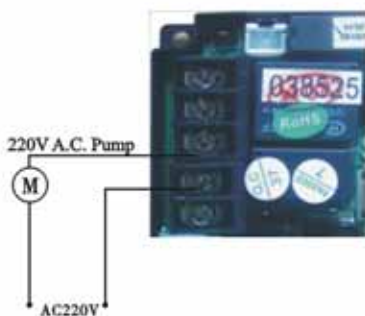

Figure 3-8 Wiring of Booster Pump on Inlet

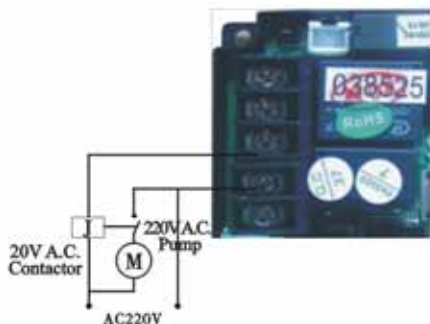

Figure 3-9 Wiring of Booster Pump on Inlet

B. Interlock

Instruction: In the parallel water treatment system, it ensures only one valve in regeneration or rising cycle and (n-1) valves in service, that is, realizing the function of supplying water simultaneously and regenerating individually.

In the series water treatment system(Second grade Na⁺ exchanger or RO pre-treatment system), it ensures only one valve in regeneration or washing cycle and there is/are water(s) in service. The wiring refer to Figure 3-10

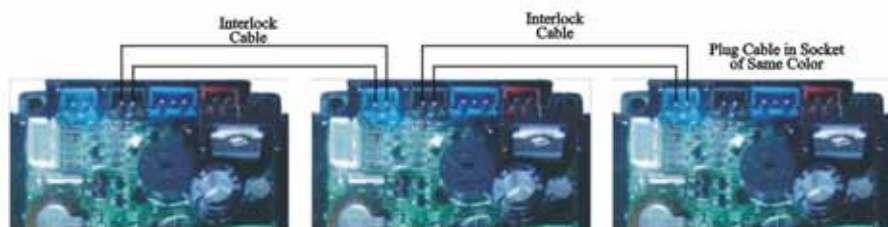

Figure 3-10 Network System Wiring with Interlock Cable

MODEL: F71B/F71G/F67C/F67G/F75A/F75B

Use interlock cable to connect CN8 to CN7 on next valve in the loop.

One system with several valves, if interlock cable is disconnected, the system is divided into two individual systems.

C. Pressure Relief Output Port

Runxin valve will cut off feeding water to drain line when it switches in rinsing cycles. Thus in some water treatment system, e.g. deep well, one booster pump is installed on the inlet to increase the system water feeding pressure, this cut-off will cause pressure on inlet rising too fast to damage the valve. Pressure Relief Output Port can be used to avoid this problem. The wiring refer to Figure3-11

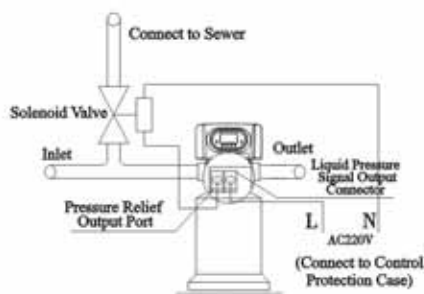

Figure 3-11 Wiring of Pressure Relief Output

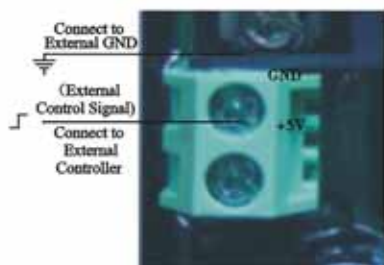

Figure 3-12 Wiring of Remote Input

D. Remote Handling Connector

Online TDS meter monitors treated water other than a flow meter, or PLC controls the rinsing time. When the controller receives a contact closure from above instruments, rinsing begins. The wiring refers to Figure3-12.

MODEL: F71B/F71G/F67C/F67G/F75A/F75B

3.3. System Configuration and Flow Rate Curve

A. Product Configuration

Product configuration with tank, filter materials volume

Tank Size	Volume of Filter Material	Carbon Filter		Sand Filter	
		Filtering Flow Rate	Backwash Flow Rate	Filtering Flow Rate	Backwash Flow Rate
mm	L	m ³ /h	m ³ /h	m ³ /h	m ³ /h
φ 180 × 1130	16	0.3	0.9	0.6	1.3
φ 205 × 1300	25	0.4	1.1	0.8	1.7
φ 255 × 1390	40	0.6	1.7	1.2	2.6
φ 300 × 1390	60	0.8	2.5	1.7	3.8
φ 355 × 1670	100	1.2	3.4	2.4	5.2
φ 400 × 1670	120	1.5	4.5	3.1	6.8
φ 450 × 1670	150	2	5.9	4.1	8.8
φ 500 × 1800	200	2.4	7	4.9	10.6
φ 600 × 1800	300	3.4	10	7	15.2

Attention: the filtering flow rate of carbon filter is calculated based on the 12m/h operation rate; the backwash flow rate is calculated based on the 10L/(m²*s) backwash intensity; the filtering flow rate of sand filter is calculated based on the 25m/h operation rate; the backwash flow rate is calculated based on the 15L/(m²*s) backwash intensity.

B.Flow Rate Characteristic

1) .Pressure-flow rate curve

MODEL: F71B/F71G/F67C/F67G/F75A/F75B

F71

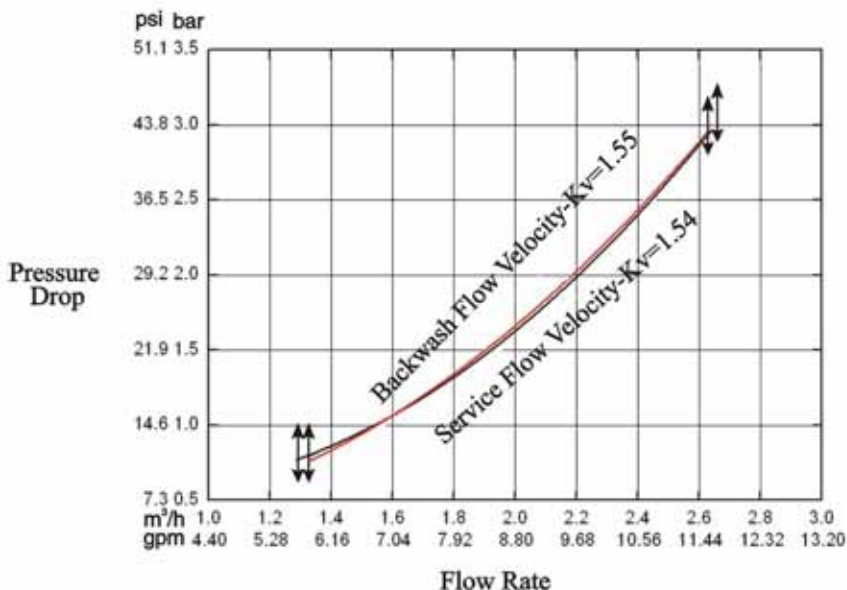

F67

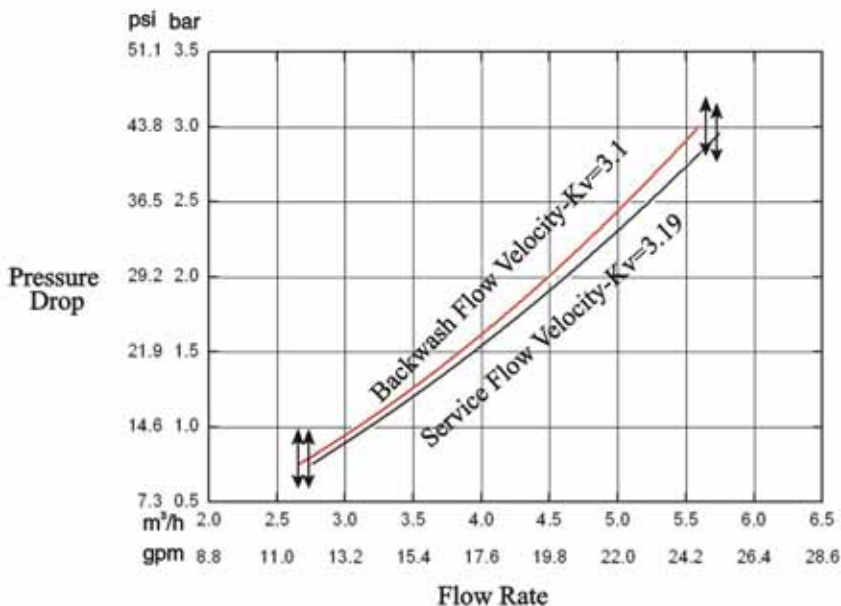

MODEL: F71B/F71G/F67C/F67G/F75A/F75B

F75

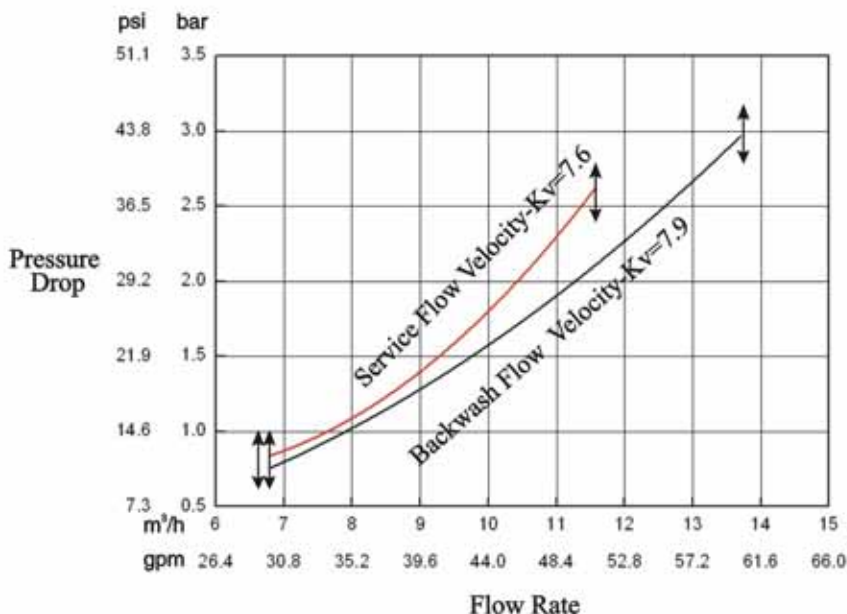

3.4. Parameter Enquiry and Setting

3.4.1. Parameter Enquiry



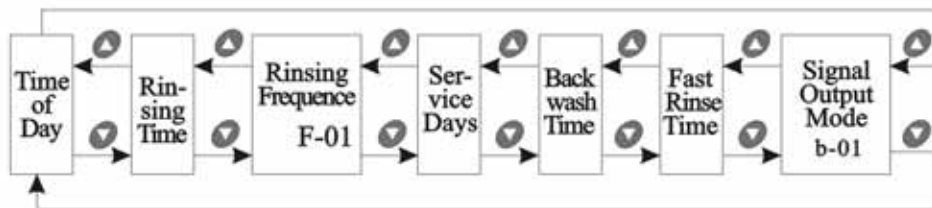































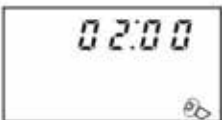





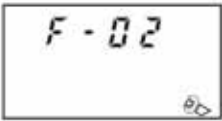





When \odot light on, press and hold both \blacktriangle and \blacktriangledown for 5 seconds to lift the button lock status; then \square press \diamond and light on, enter to program display mode; press \blacktriangle or \blacktriangledown to view each value according to below process. (Press \square exit and turn back to service status)

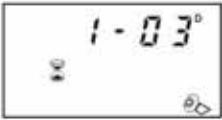







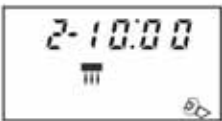





3.4.2 Parameter Setting

In program enquiry mode, press \square and enter into program set mode. Press \blacktriangle or \blacktriangledown to adjust the value.

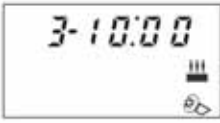
3.4.3 The steps of parameter setting

Items	Process steps	Symbol
Time of Day	<p>When the clock symbol  continuously flash, it reminds to reset;</p> <ol style="list-style-type: none"> 1. Press  to enter into program enquiry mode; both  and  symbol light on, “:” flash; 2. Press , both  and hour value flash, through  or  to adjust the hour value; 3. Press  again, both  and minute value flash, through  or  to adjust the minute value; 4. Press  and hear a sound “Di”, then finish adjustment, press  to turn back. 	
Rin-sing Time	<ol style="list-style-type: none"> 1. In the Rinsing Time program display mode, press  and enter into program set mode,  and 02 value flash; through  or  to adjust the hour value 2. Press , both  and “00” flash, through  or  to adjust the minute value; 3. Press  and hear a sound “Di”, then finish adjustment, press  to turn back. 	
Rinsing Freq- uence	<ol style="list-style-type: none"> 1. In the Rinsing Frequency display mode, it shows “F-02”; press  and enter into program set mode.  and 02 flash; 2. Press  or  to adjust the value; 3. Press  and hear a sound “Di” then finish adjustment, press  to turn back. 	
Serv- ice Days	<ol style="list-style-type: none"> 1. In the Service Days display mode, it shows  and “1-03”; press  and enter into program set mode.  and 03 flash; 2. Press  or  to adjust the value; 3. Press  and hear a sound “Di” then finish adjustment, press  to turn back. 	
Back- wash Time	<ol style="list-style-type: none"> 1. In the Backwash Time display mode, it shows  and “2-10:00”; press  and enter into program set mode.  and 10:00 flash; 2. Press  or  to adjust the value; 3. Press  and hear a sound “Di”, then finish adjustment, press  to turn back. 	

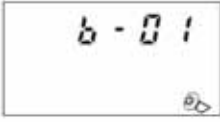

MODEL: F71B/F71G/F67C/F67G/F75A/F75B



Fast Rinse Time	<ol style="list-style-type: none">1. In the Fast Rinse Time display mode, it shows  and "3-10:00"; press  and enter into program set mode.  and 10:00 flash;2. Press  or  to adjust the value;3. Press  and hear a sound "Di" then finish adjustment, press to  turn back.	
Signal Output Mode	<ol style="list-style-type: none">1. In Signal Output Mode display mode, it shows b-01. Press  and enter into program set mode.  and 01 flash;2. Press  or  to adjust to b-02;3. Press  and hear a sound "Di", then finish adjustment, press  to turn back.	

3.5. Trial Running

After installing the multi-functional flow control valve on the tank with the connected pipes, as well as setting up the relevant parameter, please conduct the trial running as follows:

A. Close the inlet valve B & outlet valve C, and open the bypass valve A. After cleaning the foreign materials in the pipe, close the by-pass valve A. (As Figure 1-2 shows)

B. Press  and enter into the Backwash position; when  light on, slowly open the inlet valve B to 1/4 position, making the water flow into the resin tank; you can hear the sound of air-out from the drain pipeline. After all air is out of pipeline, then open inlet valve B completely and clean the foreign materials in the tank until water from drain is clean. It will take 8~10 minutes to finish the whole process.

C. Press , turning the position from Backwash to Fast Rinse;  light on and start to fast rinse. It will take 10~15 minutes to finish the whole process.



D. After finishing fast rinse, take some outlet water for testing; if the water reaches the requirement, press  to finish the fast rinse; Then the control valve return to Service Status;  light on and start to running.

Illustration:

In the process of rinsing, the program will be finished automatically in accordance with the setting time; pressing the  button can end one step in advance and proceed to the next step.

Note:

● If water inflow too fast, the media in tank will be damaged. When water inflow slowly, there is a sound of air-out from drain pipeline.

● After changing the filter materials, please empty air in the materials according to the above Step B.

MODEL: F71B/F71G/F67C/F67G/F75A/F75B

● In the process of trial running, please check the water situation in all position, ensuring there is no filter materials leakage.

● The time for Backwash and Fast Rinse position can be set and executed according to the suggestions from the control valve suppliers.

3.6. Trouble-Shooting

A. Control Valve Fault

Problem	Cause	Correction
1. Filter fails to rinse	A. Electrical service to unit has been interrupted. B. Rinse time is set incorrect. C. Valve is defective.	A. Assure permanent electrical service (check fuse, plug or switch). B. Reset the time C. Check or replace the valve
2. Filter supply raw water	A. Bypass valve is open B. Riser pipe leak C. Interval valve leak	A. Close the bypass valve B. Make sure riser pipe and O-ring are not cracked. C. Check or change valve body.
3. Water pressure lost	A. Iron is in the water supply pipe. B. Iron mass is in the filter.	A. Clean the water supply pipe. B. Clean valve and add filter materials cleaning chemical, increase frequency of rinsing.
4. Loss of filter materials through drain line	A. Air in the water system. B. The strength of backwash is too high. C. Strainer is broken.	A. Assure that the system is dry and has proper air eliminator control. B. Reduce the strength of backwash. C. Replace the strainer.
5. Control valve cycle continuously.	A. Locating signal wiring break-down. B. Valve is faulty. C. Foreign material stuck the driving gear.	A. Check and connect locating signal wiring. B. Replace valve. C. Take out foreign material.
6. Drain flows continuously.	A. Internal valve leak. B. When electricity fails to supply, the valve is in backwash or fast rinse position.	A. Check and repair valve body or replace it. B. Turn off bypass valve and restart when power on.

MODEL: F71B/F71G/F67C/F67G/F75A/F75B

B.Controller Fault

Problem	Cause	Correction
1. All indicators display on front panel.	A. Wiring of display board with control board fails to work. B. Control board is faulty. C. Transformer damaged. D. Voltage is not stable.	A. Check and replace the wiring. B. Replace control board. C. Check and replace transformer. D. Check and adjust electrical service.
2. No display on front panel.	A. Wiring of display board with control board fails to work. B. Display board damaged. C. Control board damaged. D. Electricity is interrupted.	A. Check and replace wiring. B. Replace display board. C. Replace control board. D. Check electricity.
3. E1 Flash	A. Wiring of locating board with control board fails to work. B. Locating board damaged. C. Mechanical driver fails. D. Faulty control board. E. Wiring of motor with control board is fault. F. Motor damaged.	A. Replace wiring. B. Replace locating board. C. Check and repair mechanical part. D. Replace control board. E. Replace wiring. F. Replace motor.
4. E2 Flash	A. Hall component on locating board damaged. B. Wiring of locating board with control board fails to work. C. Control board is faulty.	A. Replace locating board. B. Replace wiring. C. Replace control board.
5. E3 or E4 Flash	A. Control board is faulty.	A. Replace control board.

MODEL: F71B/F71G/F67C/F67G/F75A/F75B

3.7. Assembly & Parts

F71B (53502) Valve Body Assembly

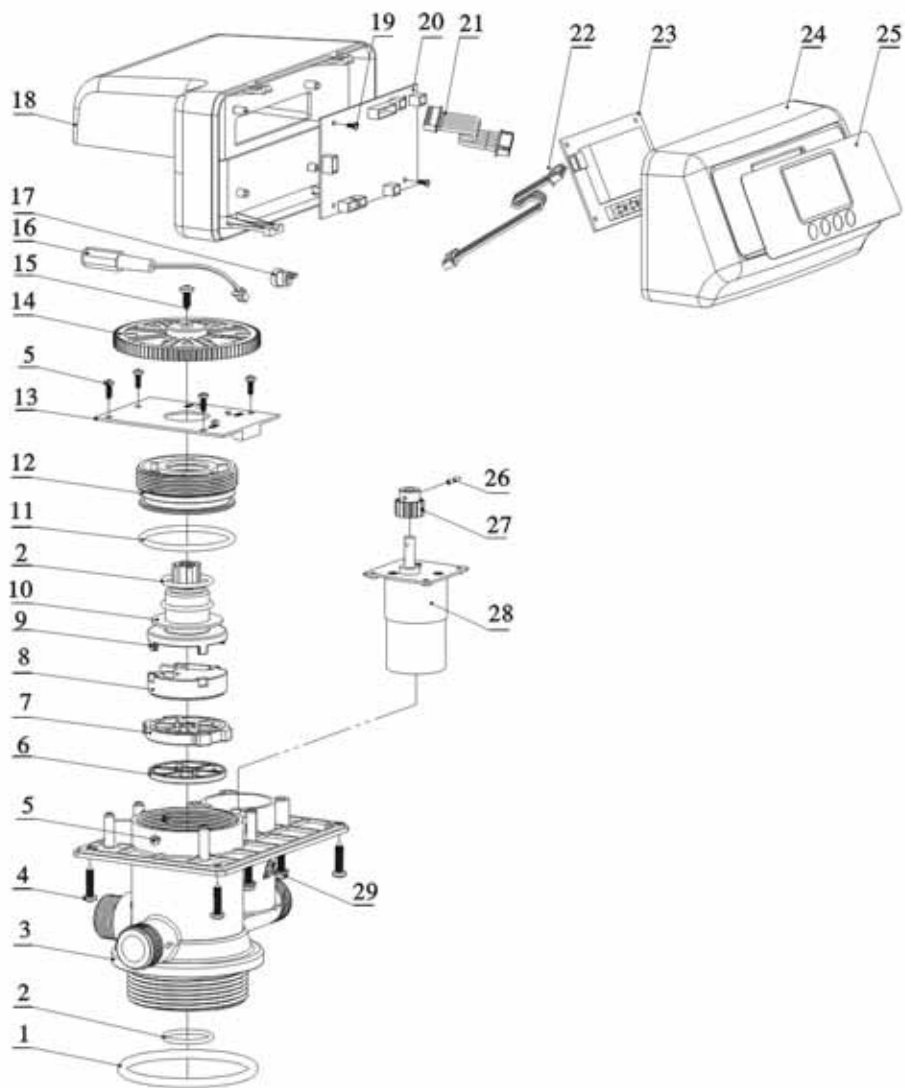

MODEL: F71B/F71G/F67C/F67G/F75A/F75B

F71B (53502) Valve Body Components

Item No.	Description	Part Number	Quantity	Item No.	Description	Part Number	Quantity
1	O-ring 73 × 5.3	8378143	1	15	Screw, Cross ST3.9 × 13	8909013	1
2	O-ring 25.8 × 2.65	8378078	1	16	Wire for Power	5513001	1
3	Valve Body (ABS+GF10)	8022048	1	17	Cable Clip	8126004	1
	Valve Body (PPO+GF20)	8022049		18	Dust Cover	8005005	1
4	Screw, Cross ST3.9 × 16	8909016	4	19	Screw, Cross ST2.2 × 6.5	8909004	2
5	Screw, Cross ST2.9 × 9.5	8909008	7	20	Control Board	6382003	1
6	Sealing Ring	8370038	1	21	Wire for Locating Board	5511001	1
7	Moving Disk	8469018	1	22	Wire for Display Board	5512001	1
8	Fixed Disk	8459019	1	23	Display Board	6381003	1
9	Shaft	8258009	1	24	Front Cover	8300004	1
10	Anti-friction Washer	8216010	1	25	Label	8865004	1
11	O-ring 50.39 × 3.53	8378107	1	26	Pin Φ 2.5 × 12	8993003	1
12	Fitting Nut	8092007	1	27	Small Gear, Motor	8241010	1
13	Locating Board	6380009	1	28	Motor	6158006	1
14	Big Gear, Driven	5241005	1	29	Screw, Cross M4 × 25	8902008	4

MODEL: F71B/F71G/F67C/F67G/F75A/F75B

F71G (53502B) Valve Body Assembly

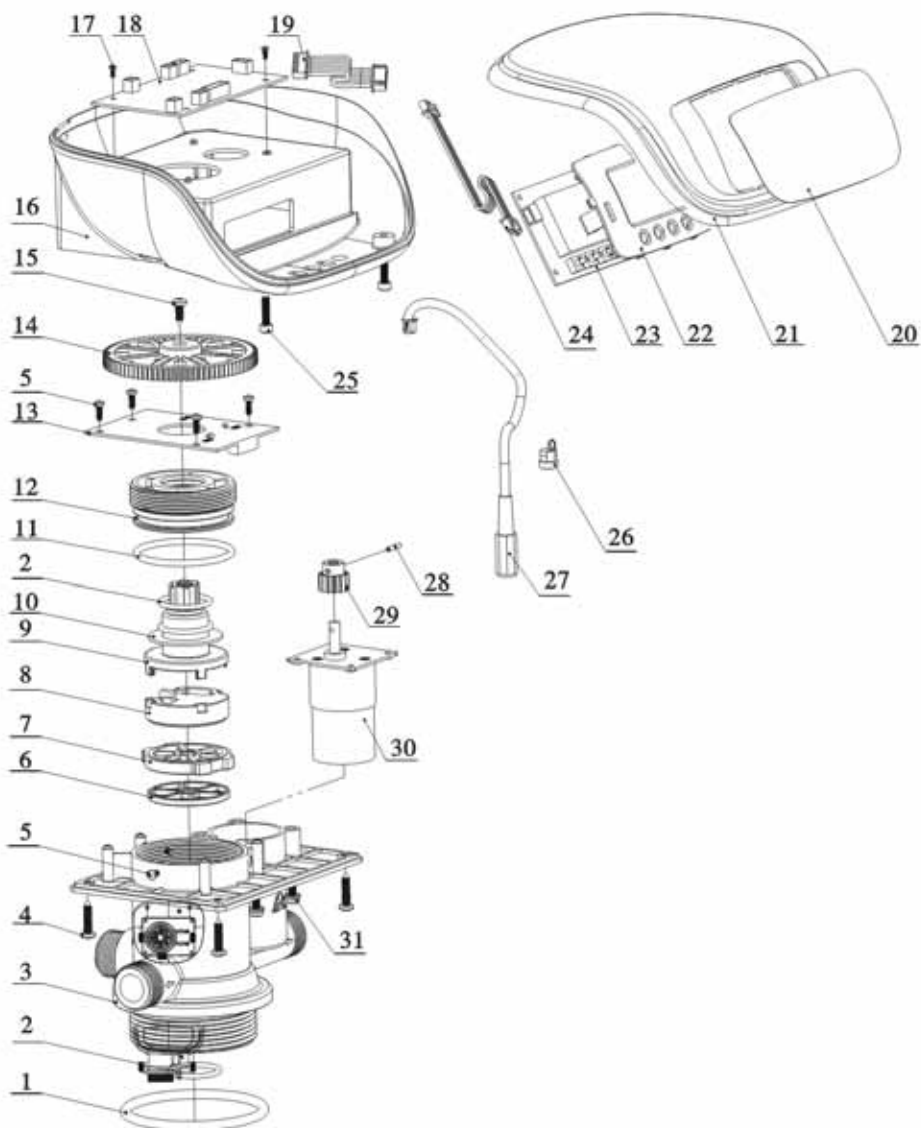

MODEL: F71B/F71G/F67C/F67G/F75A/F75B

F71G (53502B) Valve Body Components

Item No.	Description	Part Number	Quantity	Item No.	Description	Part Number	Quantity
1	O-ring 73 × 5.3	8378143	1	16	Dust Cover	8005020	1
2	O-ring 25.8 × 2.65	8378078	1	17	Screw, Cross ST2.2 × 6.5	8909004	2
3	Valve Body (ABS+GF10)	8022048	1	18	Control Board	6382003	1
	Valve Body (PPO+GF20)	8022049		19	Wire for Locating Board	5511001	1
4	Screw, Cross ST3.9 × 16	8909016	4	20	Label	8865021	1
5	Screw, Cross ST2.9 × 9.5	8909008	7	21	Front Cover	8300702	1
6	Sealing Ring	8370038	1	22	Toggle	8109028	1
7	Moving Disk	8469018	1	23	Display Board	6381003	1
8	Fixed Disk	8459019	1	24	Wire for Display Board	5512001	1
9	Shaft	8258009	1	25	UBK M4 × 16	8902016	2
10	Anti-friction Washer	8216010	1	26	Cable Clip	8126004	1
11	O-ring 50.39 × 3.53	8378107	1	27	Wire for Power	5513001	1
12	Fitting Nut	8092007	1	28	Pin Φ2.5 × 12	8993003	1
13	Locating Board	6380009	1	29	Small Gear, Motor	8241010	1
14	Big Gear, Driven	5241005	1	30	Motor	6158006	1
15	Screw, Cross ST3.9 × 13	8909013	1	31	Screw, Cross M4 × 25	8902008	4

MODEL: F71B/F71G/F67C/F67G/F75A/F75B

F67C (53504) Valve Body Assembly

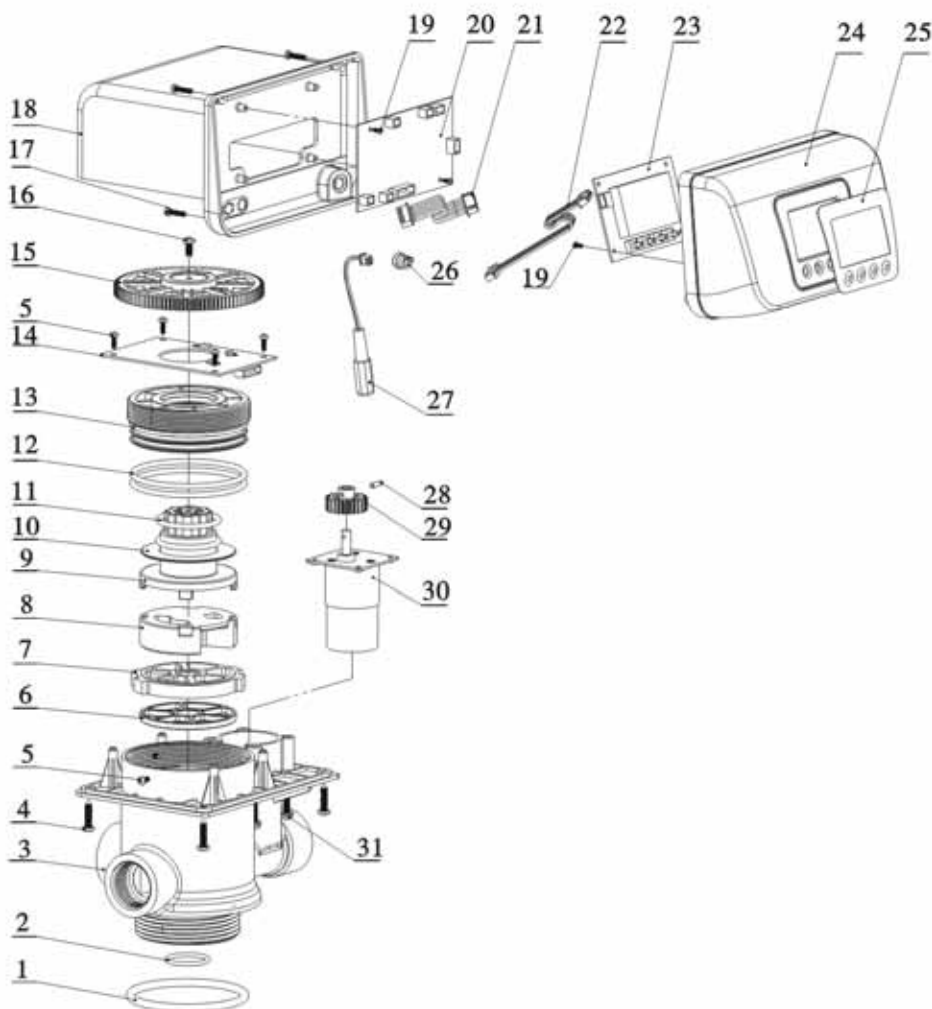

MODEL: F71B/F71G/F67C/F67G/F75A/F75B

F67C (53504) Valve Body Components

Item No.	Description	Part Number	Quantity	Item No.	Description	Part Number	Quantity
1	O-ring 73 × 5.3	8378143	1	16	Screw, Cross ST3.9 × 13	8909013	1
2	O-ring 25.8 × 2.65	8378078	1	17	Screw, Cross ST2.9 × 16	8909010	4
3	Valve Body (ABS+GF10)	8022039	1	18	Dust Cover	8005006	1
	Valve Body (PPO+GF20)	8022040		19	Screw, Cross ST2.2 × 6.5	8909004	4
4	Screw, Cross ST3.9 × 16	8909016	4	20	Control Board	6382003	1
5	Screw, Cross ST2.9 × 9.5	8909008	7	21	Wire for Locating Board	5511001	1
6	Sealing Ring	8370027	1	22	Wire for Display Board	5512001	1
7	Moving Disk	8469013	1	23	Display Board	6381003	1
8	Fixed Disk	8459014	1	24	Front Cover	8300001	1
9	Shaft	8258004	1	25	Label	8865002	1
10	Anti-friction Washer	8216004	1	26	Cable Clip	8126004	1
11	O-ring 37.7 × 3.55	8378119	2	27	Wire for Power	5513001	1
12	O-ring 73 × 3.55	8378128	2	28	Pin Φ2.5 × 12	8993003	1
13	Fitting Nut	8092004	1	29	Small Gear, Motor	8241003	1
14	Locating Board	6380004	1	30	Motor	6158021	1
15	Big Gear, Driven	5241002	1	31	Screw, Cross M4 × 30	8902009	4

MODEL: F71B/F71G/F67C/F67G/F75A/F75B

F67G (53504B) Valve Body Assembly

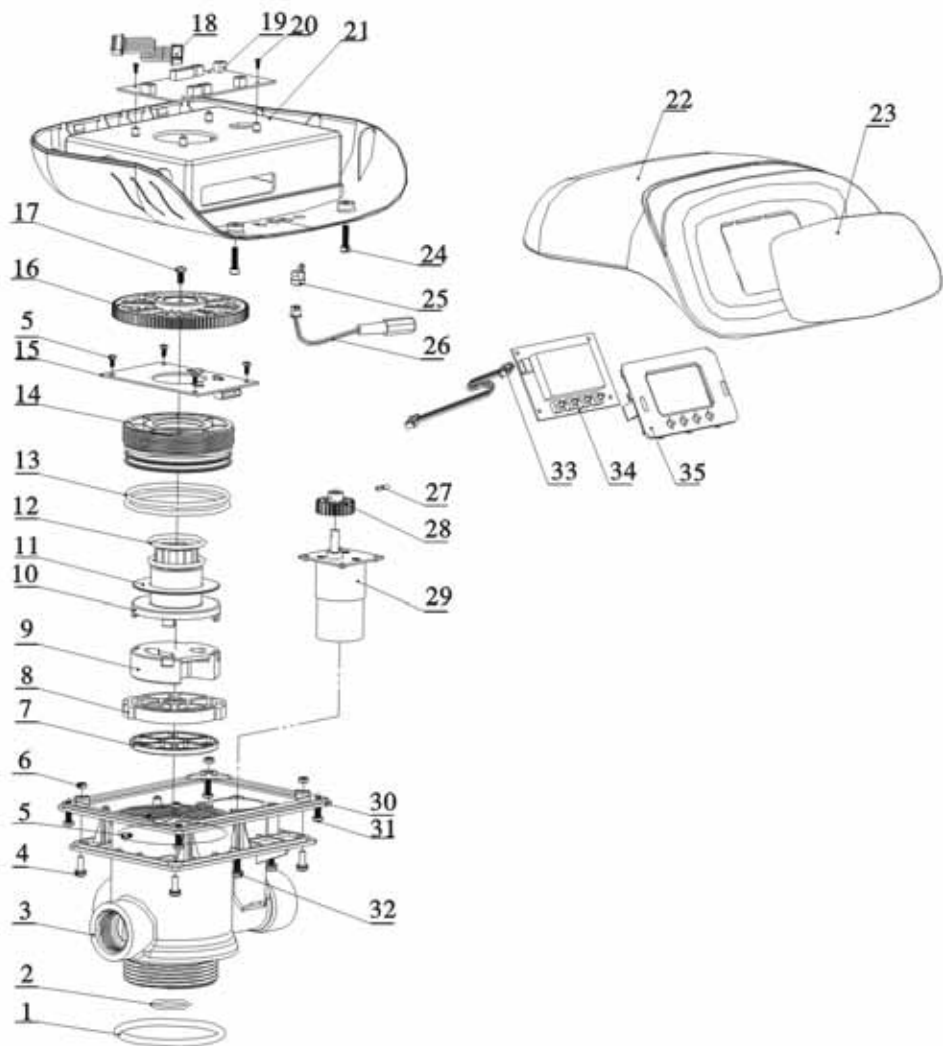

MODEL: F71B/F71G/F67C/F67G/F75A/F75B

F67G (53504B) Valve Body Components

Item No.	Description	Part Number	Quantity	Item No.	Description	Part Number	Quantity
1	O-ring 73 × 5.3	8378143	1	17	Screw, Cross ST3.9 × 13	8909013	1
2	O-ring 25.8 × 2.65	8378078	1	18	Wire for Locating Board	5511001	1
3	Valve Body (ABS+GF10)	8022039	1	19	Control Board	6382003	1
	Valve Body (PPO+GF20)	8022040		20	Screw, Cross ST2.2 × 6.5	8909004	2
4	Screw, Cross M4 × 12	8902005	4	21	Dust Cover	8005019	1
5	Screw, Cross ST2.9 × 9.5	8909008	7	22	Front Cover	5300001	1
6	Hexagonal Nut	8940002	4	23	Label	8865020	1
7	Sealing Ring	8370027	1	24	UBK M4 × 16	8902016	2
8	Moving Disk	8469013	1	25	Cable Clip	8126004	1
9	Fixed Disk	8459014	1	26	Wire for Power	5513001	1
10	Shaft	8258004	1	27	Pin Φ 2.5 × 12	8993003	1
11	Anti-friction Washer	8216004	1	28	Small Gear, Motor	8241003	1
12	O-ring 37.7 × 3.55	8378119	2	29	Motor	6158021	1
13	O-ring 73 × 3.55	8378128	2	30	Connecting Plate	8152014	1
14	Fitting Nut	8092004	1	31	Screw, Cross ST3.9 × 16	8909016	4
15	Locating Board	6380004	1	32	Screw, Cross M4 × 30	8902009	4
16	Big Gear, Driven	5241002	1				

MODEL: F71B/F71G/F67C/F67G/F75A/F75B

F75A (53510) Valve Body Assembly:

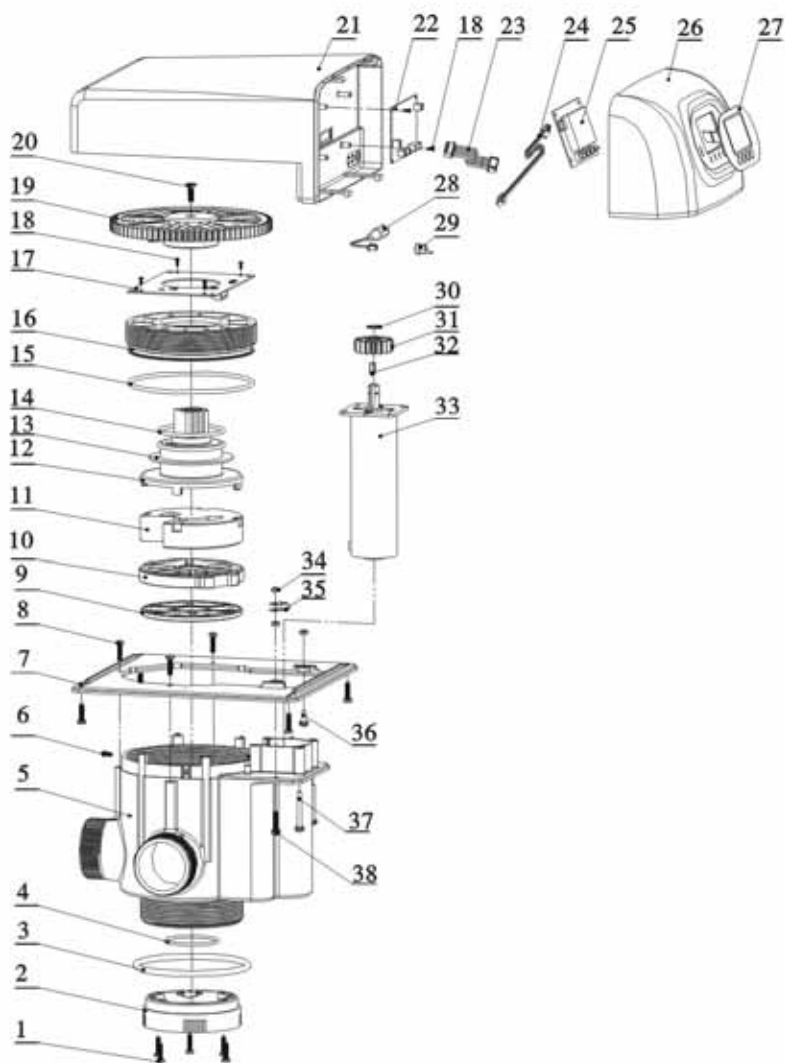

MODEL: F71B/F71G/F67C/F67G/F75A/F75B

F75A (53510) Valve Body Components

Item No.	Description	Part Number	Quantity	Item No.	Description	Part Number	Quantity
1	Screw, Cross ST3.9 × 19	8909003	5	20	Screw, Cross ST4.8 × 19	8909018	1
2	Connector	8458018	1	21	Dust Cover	8005010	1
3	O-ring 104.6 × 5.7	8378146	1	22	Control Board	6382027	1
4	O-ring 48.9 × 2.62	8378071	1	23	Wire for Locating Board	5511002	1
5	Valve Body (ABS+GF10)	8022055	1	24	Wire for Display Board	5512001	1
	Valve Body (PPO+GF10)	8022056					
6	Screw, Cross ST2.9 × 9.5	8909008	3	25	Display Board	6381003	1
7	Connecting Plate	8152007	1	26	Front Cover	8300017	1
8	Screw, Cross ST3.9 × 16	8909016	7	27	Label	8865016	1
9	Sealing Ring	8370014	1	28	Wire for Power	5513001	1
10	Moving Disk	8469009	1	29	Cable Clip	8126004	1
11	Fixed Disk	8459022	1	30	Circlip	8994009	1
12	Shaft	8258005	1	31	Small Gear, Motor	8241008	1
13	Anti-friction Washer	8216006	1	32	Bolt C4 × 12	8971001	1
14	O-ring 59.92 × 3.53	8378110	2	33	Motor	6158037	1
15	O-ring 117.6 × 3.55	8378133	1	34	Hexagonal Nut	8940002	3
16	Fitting Nut	8092005	1	35	Cable Clip	8126002	1
17	Locating Board	6380016	1	36	Screw, Cross M4 × 12	8902005	1
18	Screw, Cross ST2.2 × 6.5	8909004	6	37	Screw, Cross M4 × 36.5	8902012	4
19	Big Gear, Driven	5241014	1	38	Screw, Cross M4 × 20	8902007	1

MODEL: F71B/F71G/F67C/F67G/F75A/F75B

F75B (53510B) Valve Body Assembly

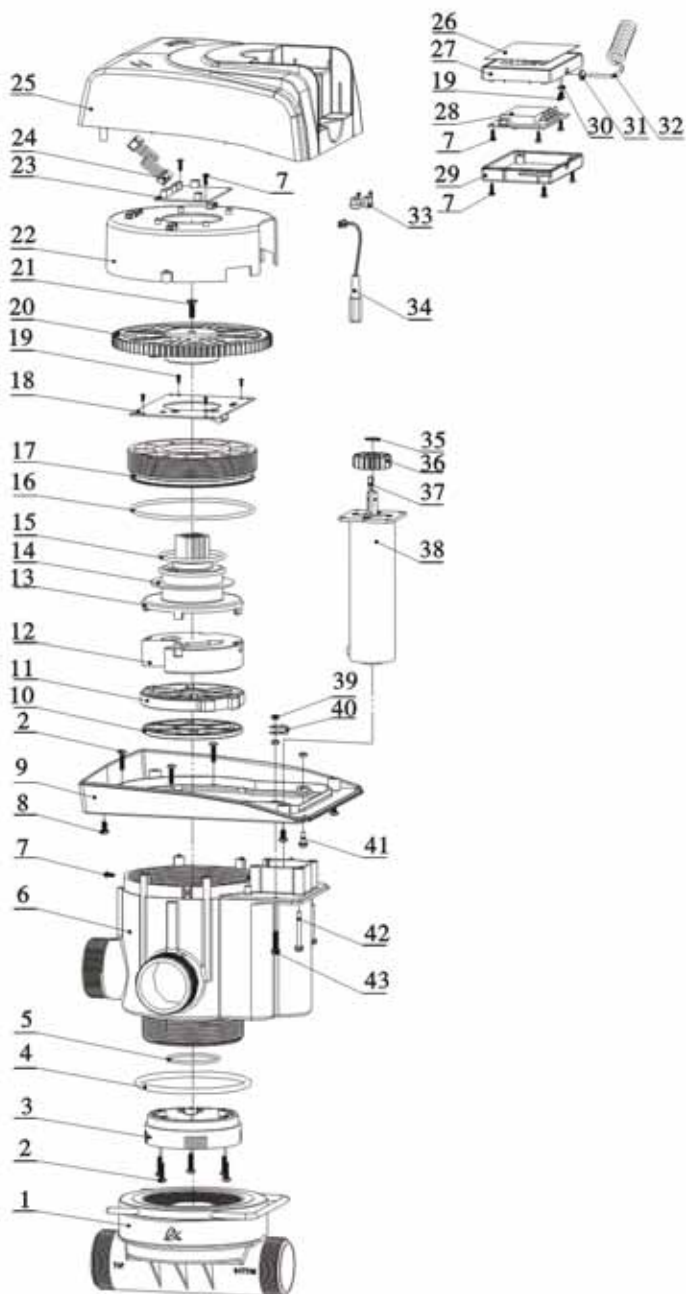

MODEL: F71B/F71G/F67C/F67G/F75A/F75B

F75B (53510B) Valve Body Components

Item No.	Description	Part Number	Quantity	Item No.	Description	Part Number	Quantity
1	Side-mounted Connector	5458002	1	22	Fixing Seat	8109004	1
2	Screw, Cross ST3.9 × 19	8909003	8	23	Locating Board	6382027	1
3	Connector	8458018	1	24	Wire for Locating Board	5511002	1
4	O-ring 104.6 × 5.7	8378146	1	25	Dust Cover	8005023	1
5	O-ring 48.9 × 2.62	8378071	1	26	Label	8865023	1
6	Valve Body (ABS+GF10)	8022055	1	27	Front Cover	8300025	1
	Valve Body (PPO+GF10)	8022056		28	Display Board	6381003	1
7	Screw, Cross ST2.9 × 9.5	8909008	15	29	Cover	8315016	1
8	Screw, Cross ST3.9 × 13	8909013	4	30	Cable Clip	8126001	1
9	Connecting Plate	8152012	1	31	Bushings	8126006	1
10	Sealing Ring	8370014	1	32	Spring Wire	5517001	1
11	Fixed Disk	8469009	1	33	Cable Clip	8126004	2
12	Moving Disk	8459022	1	34	Wire for Power	5513001	1
13	Shaft	8258005	1	35	Circlip	8994009	1
14	Anti-friction Washer	8216006	1	36	Small Gear, Motor	8241008	1
15	O-ring 59.92 × 3.53	8378110	2	37	Bolt C4 × 12	8971001	1
16	O-ring 117.6 × 3.55	8378133	1	38	Motor	6158037	1
17	Fitting Nut	8092005	1	39	Hexagonal Nut	8940002	3
18	Locating Board	6380016	1	40	Cable Clip	8126002	1
19	Screw, Cross ST2.2 × 6.5	8909004	6	41	Screw, Cross M4 × 12	8902005	1
20	Big Gear, Driven	5241014	1	42	Screw, Cross M4 × 36.5	8902012	4
21	Screw, Cross ST4.8 × 19	8909018	1	43	Screw, Cross M4 × 20	8902007	1

MODEL: F71B/F71G/F67C/F67G/F75A/F75B

5458002 Side-mounted Connector Body Assembly

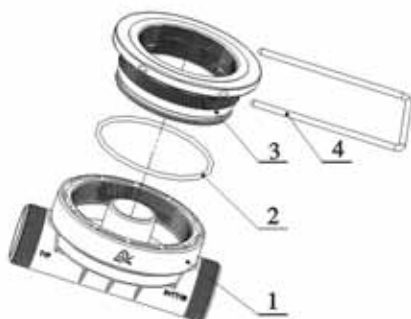

5458002 Side-mounted Connector Body Components

Item No.	Description	Part Number	Quantity	Item No.	Description	Part Number	Quantity
1	Connection	8458037	1	3	Connector	8457017	1
2	O-ring 110 × 4.5	8378140	1	4	Steel Fork	8271003	1

4. Warranty Card

Dear client:

This warranty card is the guarantee proof of RUNXIN brand multi-functional flow control valve. It is kept by client self. You could get the after-sales services from the supplier which is appointed by RUNXIN manufacturer. Please keep it properly. It couldn't be retrieved if lost. It couldn't be repaired free of charge under the below conditions:

1. Guarantee period expired.(One year);
2. Damage resulting from using, maintenance, and keeping that are not in accordance with the instruction;
3. Damage resulting from repairing not by the appointed maintenance personnel;
4. Content in guarantee proof is unconfirmed with the label on the real good or be altered;
5. Damage resulting from force majeure.

Product Name		Multi-functional Flow Control Valve for Water Treatment Systems		
Model		Code of Valve Body		
Purchase Company Name		Tel/Cel.		
Problem				
Solution				
Date of Repairing		Date of Accomplishment		Maintenance Man Signature

When product need warranty service, please fill in the below content and sent this card together with the product to the appointed suppliers or Runxin company.

End-user Company Name		Tel/Cel.		
Purchase Company Name		Tel/Cel.		
Model	Code of Valve Body			
Tank Size ϕ	\times	Filter Material	Kg	Water Source: Ground-water <input type="checkbox"/> Tap Water <input type="checkbox"/>
Service Time	D or h	Backwash Time	min	Fast Rinse Time min
Problem Description				



WENZHOU RUNXIN MANUFACTURING MACHINE CO.,LTD

ADD: Jinger Road, Shatou Group, Linjiang, Lucheng District, Wenzhou, Zhejiang, China

Tel: +86-577-88635628 88630038 Fax: +86-0577-88633258

Http://www.run-xin.com Email:sales@run-xin.com