



International Patent Public No.:  
WO 2006/007772  
China Patent No.: ZL201520680239.8  
US Patent No.: 7549446  
India Patent No.: 232582  
Russia Patent No.:2349819  
South Korea Patent No.:10-0914137  
Mexico Patent No.: 268581  
Australia Patent No.: 2005263257  
Philippine Patent No.: 1-2006-502553  
Taiwan Patent No.:M287896

## Multi-functional Flow Control Valve for Water Treatment Systems

55504 (Old Model No.:F67Q1)  
55604 (Old Model No.:F67Q3)  
55502 (Old Model No.:F71Q1)  
55602 (Old Model No.:F71Q3)  
75504 (Old Model No.:F68Q1)  
75604 (Old Model No.:F68Q3)  
75502 (Old Model No.:F69Q1)  
75602 (Old Model No.:F69Q3)  
65505 (Old Model No.:F116Q1)  
65605 (Old Model No.:F116Q3)  
65503 (Old Model No.:F117Q1)  
65603 (Old Model No.:F117Q3)

## User Manual

Please read this manual in details  
before using the valve and keep it properly  
in order to consult in the future.

0WRX.466.708

### **WENZHOU RUNXIN MANUFACTURING MACHINE CO.,LTD**

ADD: NO.169, RUNXIN ROAD, SHANFU TOWN, WENZHOU, ZHEJIANG, CHINA.

TEL.:0086-577-88630038, 88576512, 85956057 FAX:0086-577-88633258



E-MAIL: sales@run-xin.com <http://www.run-xin.com>

Rev.A.1903

MODEL: F67Q/F71Q/F68Q/F69Q/F116Q/F117Q

Before the valve put into use, please fill in the below content for future reference.

**The Program Type Setting (Operation by professional)**

When all symbols light on, press and hold “” and “” buttons for 5 seconds to enter the menu of valve model selection. **Please set the program type in accordance with the product type.** (Time clock type by days or meter type, for example, F67Q1 should be set as 67Q1; F67Q3 should be set as 67Q3 etc., it should not be set to other type.)

**Softener System Configuration**

Tank Size: Dia. \_\_\_\_\_ mm, Height \_\_\_\_\_ mm; Resin Volume \_\_\_\_\_ L;  
Brine Tank Capacity \_\_\_\_\_ L; Hardness of Raw water \_\_\_\_\_ mmol/L;  
Pressure of Inlet Water \_\_\_\_\_ MPa; Control Valve Model \_\_\_\_\_;  
Number \_\_\_\_\_; Specifications of Drain Line Flow Control \_\_\_\_\_;  
Injector No. \_\_\_\_\_.

Water Source: Ground-water  Filtered Ground-water  Tap Water  Other \_\_\_\_\_.

**Filter System Configuration**

Tank Size: Dia. \_\_\_\_\_ mm, Height \_\_\_\_\_ mm; Filter Material \_\_\_\_\_ Kg;  
Filter Material Height \_\_\_\_\_ mm; Turbidity of Inlet Water \_\_\_\_\_ FTU;  
Pressure of Inlet Water \_\_\_\_\_ Mpa; Control Valve Model \_\_\_\_\_;  
Number \_\_\_\_\_;

Water Source: Ground-water  Filtered Ground-water  Tap Water  Other \_\_\_\_\_.

**Parameter Setting**

Parameter	Unit	Factory Default	Actual Value
Control Mode A-01/02 (Q3 meter type available)	/	A-01	
Unit Mode HU-1/2 (Q3 meter type available)	/	HU-1	
Water Treatment Capacity (Q3 meter type available)	m <sup>3</sup>	10	
Service Days (Time type by day)	D.	03	
Regeneration Time	/	02:00	
Backwash Interval Times (F68Q/F69Q available)	/	F-00	
Rinsing Frequence (F67Q/F71Q available)	/	F-00	
Backwash Time	min.	10	
Brine & Slow Rinse Time (F67Q/F71Q unavailable)	min.	60	
Brine Refill Time (F67Q/F71Q unavailable)	min.	05	
Fast Rinse Time	min.	10	
Interval Regeneration Days (Q3 meter type available)	D	30	
Output Mode b-01(02)	/	b-01	

● If there is no special requirement when product purchase, F68Q is without the drain line flow control, and choose 8# injector as the standard configuration. We choose 8468077 drain line flow control, and 4# injector for F69Q as standard configuration. F116Q is without the drain line flow control, and choose 9# injector as the standard configuration. We choose 8468062 drain line flow control, and 7# injector for F69Q as standard configuration.

**Catalogue**

Notice.....	1
1. Product Overview .....	2
1.1. Main Application & Applicability .....	2
1.2. Product Characteristics .....	2
1.3. Service Conditions .....	4
1.4. Product Structure and Technical Parameters .....	5
1.5. Installation .....	8
2. Basic Setting & Usage .....	11
2.1. The Function of PC Board .....	11
2.2. Basic Setting & Usage(F116Q3 A-01 as example) .....	13
3. Applications .....	16
3.1. Flow Chart .....	16
3.2. The Function and Connection of PC Board .....	17
A. Signal Output Connector .....	17
B. Interlock .....	20
C. Double (Multiple) Valves, Supply Water Simultaneously and Regenerate Separately.....	21
3.3 System Configuration and Flow Rate Curve .....	22
3.4 Parameter settlement .....	28
3.5 Parameter Enquiry and Setting .....	30
3.6 Trial Running .....	33
3.7 Trouble-Shooting .....	35
3.8 Assembly & Parts .....	38
4. Warranty Card.....	52

**Notice**

- To ensure normal operation of the valve, please consult with professional installation or maintenance personnel before using it.
- If there is any pipeline engineering and electric works, it must be finished by professional at the time of installation.
- Do not use the control valve with the unsafe or the quality-unknown water.
- Depending on the changing of working environment and water requirement, each parameter of softener should be adjusted accordingly.
- When the water treatment capacity is too low, please check the resin. If the reason is shortage of resin, please add; if the resin turns to reddish brown or broken, please replace.
- Test water quality periodically to verify that system is performing satisfactorily.
- Sodium used in the water softening process should be considered as part of your overall dietary salt intake. Contact your doctor if you are on a low sodium diet.
- When this valve is used for softening, please ensure the solid salt is available in the brine tank all the time during use. The brine tank should be added by the clean water softening salts only, at least 99.5% pure, forbidding use the small salt.
- Do not put the valve near the heat resource, high humidity, corrosive, intense magnetic field or intense vibrations environment. And do not leave it outside.
- Forbidden to pull the injector body. Avoid to use injector body as support to carry the system.
- Forbidden to use the brine tube or other connectors as support to carry the system.
- Please use this product under water temperatures between 5~50℃, water pressure 0.15~0.6MPa. Failure to use this product under such conditions voids the warranty.
- If the water pressure exceeds 0.6MPa, a pressure reducing valve must be installed in front of the water inlet. While, if the water pressure under 0.15MPa, a booster pump must be installed in front of the water inlet.
- It is suggested to install PPR pipe, corrugated pipe or UPVC pipe, instead of TTLSG pipe.
- Do not let children touch or play, because carelessness operating may cause the procedure changed.
- When the attached cables of this product and transformer are changed, the replaced must come from our factory.

## 1. Product Overview

### 1.1. Main Application & Applicability

Used for intelligent filtering, demineralization and softening in the water treatment systems.

F67Q/F71Q (Filter)

Residential filtration system

RO pretreatment active carbon and sand filtration system, etc.

F116Q/F117Q (Down-flow regeneration), F68Q/F69Q (Up-flow regeneration)

Applicable for the ion exchange equipment which hardness of the raw water  $\leq 6.5\text{mmol/L}$

Boiler softening water system

RO pretreatment softening system, etc.

### 1.2. Product Characteristics

#### ● Simple structure and reliable sealing

The distribution valve adopts hermetic head faces with high degree pottery and corrosion resistance for opening and closing. It combines with Service, Backwash, Brine & Slow Rinse, Fast Rinse and Brine Refill.

#### ● No water pass the valve in regeneration in single tank type.

#### ● Manual function

Realize regeneration immediately by pushing manual button “” at any time.



#### ● Long outage indicator

If outage overrides 3 days, the time of day indicator “12:12” will flash to remind people to reset new time of day. The other set parameters do not need to reset. The process will continue to work after power on.

#### ● The valve will automatically rotate for more than ten seconds after it is power on

After the valve power on, it will automatically rotate for more than ten seconds to turn back to the position when the electricity is cut off.



#### ● Buttons lock

No operations to buttons on the controller within 1 minute, button lock indicator lights on which represents buttons are locked. Before operation, press and hold the “” and “” buttons for 5 seconds to unlock. This function can avoid incorrect operation.

#### ● Interval backwash times (Suitable for F68Q/F69Q)

It could set up interval backwash times for F68Q/F69Q up-flow regeneration valve, which means several times of services but one time of backwash. The setting of interval backwash times depends on the local water turbidity. (The lower the turbidity is, the longer of the interval backwash times can be set)

#### ● It can choose time clock type or meter type by program selection

When all symbols light on, press and hold “” and “” buttons for 5 seconds to enter the menu of valve model selection. Please set the program type in accordance with the product type. (Tim clock type by days or meter type) (Notice: The meter type product has one flow meter and flow meter cable, but the time clock type does not).

#### ● Two meter types can be selected (Suitable for F67Q3, F68Q3, F69Q3, F71Q3, F116Q3, F117Q3)

Model	Name	Instruction
A-01	Meter Delayed	Regenerate on the day although the available volume of treated water drops to zero (0). Regeneration starts at the regeneration time.
A-02	Meter Immediate	Regenerate immediately when the available volume of treated water drops to zero(0).

#### ● Interlock function

It has a interlock function to realize only one valve in regeneration but the others are in service while several valves are in parallel connection or in series connection in the system. In multi-steps treatment systems such as RO pre-treatment, when several valves are in series, there is only one valve in regeneration or washing to ensure there is water passing all the times while different valves in regeneration or washing. (Application refer to Figure 3-9)

#### ● Signal Output (F116Q as example)

There is a signal output connector on the main control board. It is for controlling external wiring (Refer to figures from Figure3-1 to Figure 3-8).

There are two kinds of output modes: b-01 Mode: Turn on when regeneration started and shut off at the end of regeneration; b-02 Mode: Signal available only at intervals of regeneration cycles and in service.

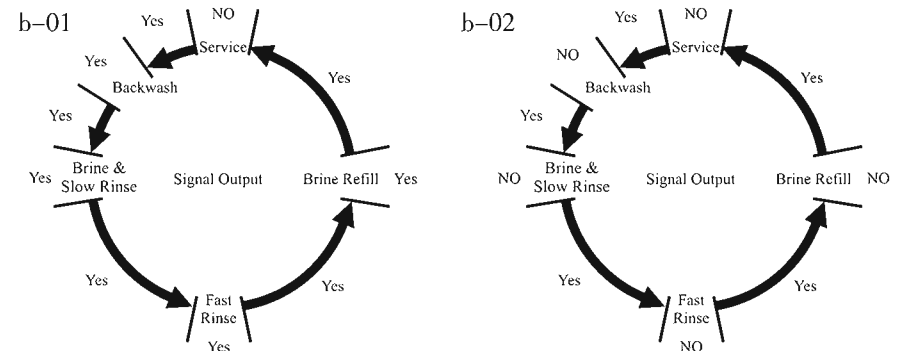

MODEL: F67Q/F71Q/F68Q/F69Q/F116Q/F117Q

●User can set the maximum interval regeneration days (Only for F67Q3/ F68Q3/ F69Q3/F71Q3/F116Q3/F117Q3)

In the situation of service reaching the setting days but the volume not yet, it could enter into regeneration process forcibly when current time is the same as regeneration time.

●All parameters can be modified

According to the water quality and usage, the parameters in the process can be adjusted.

**1.3. Service Conditions**

Runxin Valve should be used under the below conditions:

Items		Requirement
Working Conditions	Water pressure	0.15MPa~0.6MPa
	Water temperature	5℃~50℃
Working Environment	Environment temperature	5℃~50℃
	Relative humidity	≤95%(25℃)
	Electrical facility	AC100~240V/50~60Hz
Inlet Water Quality	Water turbidity	Filter < 20FTU Down-flow regeneration < 5FTU; Up-flow regeneration < 2FTU
	Water hardness	First Grade Na+ < 6.5mmol/L; Second Grade Na+ < 10mmol/L
	Free chlorine	< 0.1mg/L
	Iron <sup>2+</sup>	< 0.3mg/L
	CODMn	< 2mg/L(O <sub>2</sub> )

In the above table, First Grade Na<sup>+</sup> represents First Grade Na<sup>+</sup> Exchanger. Second Grade Na<sup>+</sup> represents Second Grade Na<sup>+</sup> Exchanger.

●When the water turbidity exceeds the conditions, a filter should be installed on the inlet of control valve.

●When the water hardness is exceeds the conditions, the outlet water hardness will hardly reach the requirement of boiler feed water (0.03mmol/L). It is suggested to adopt second grade softener.

MODEL: F67Q/F71Q/F68Q/F69Q/F116Q/F117Q

**1.4. Product Structure and Technical Parameters**

**A. Product dimension (The appearance is just for reference. It is subject to the real product.)**

F67Q1 structure chart:

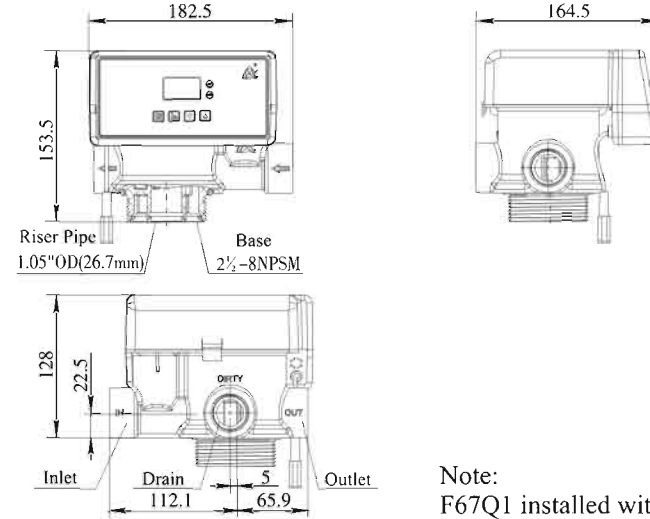

Note:  
F67Q1 installed with flow meter is F67Q3;

F68Q1 structure chart:

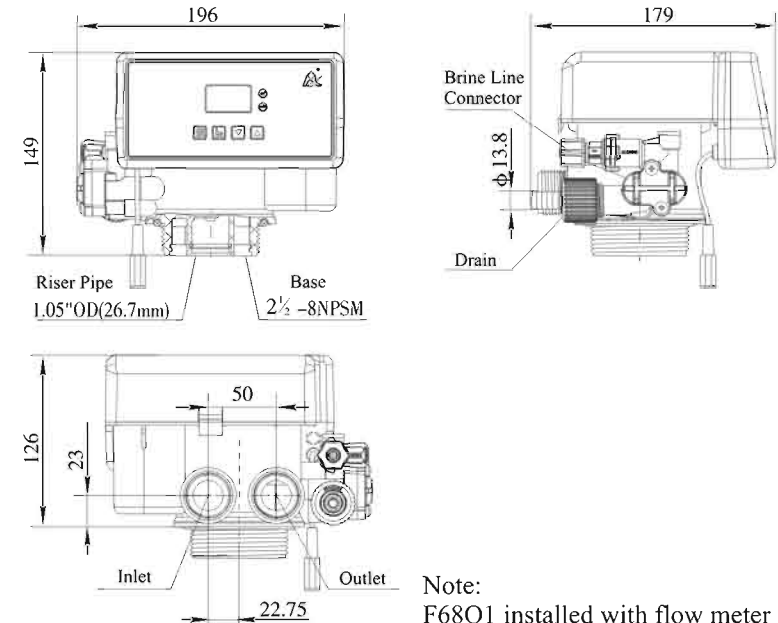

Note:  
F68Q1 installed with flow meter is F68Q3;

MODEL: F67Q/F71Q/F68Q/F69Q/F116Q/F117Q

F69Q1 structure chart:

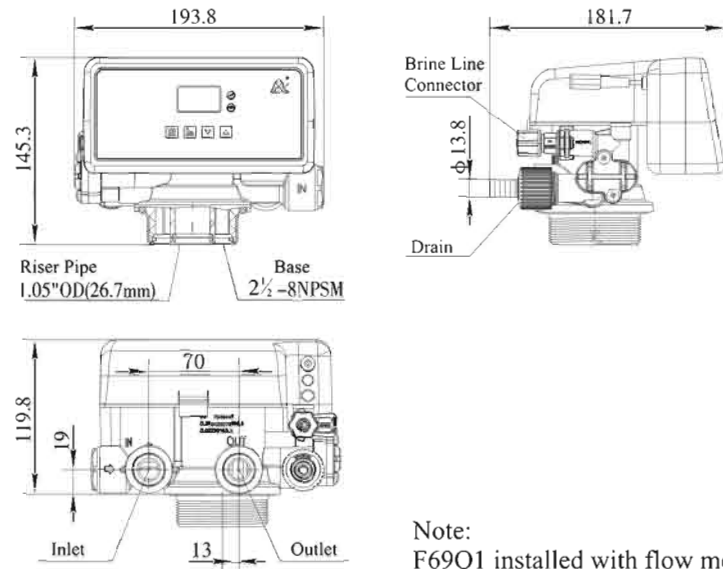

F71Q1 structure chart:

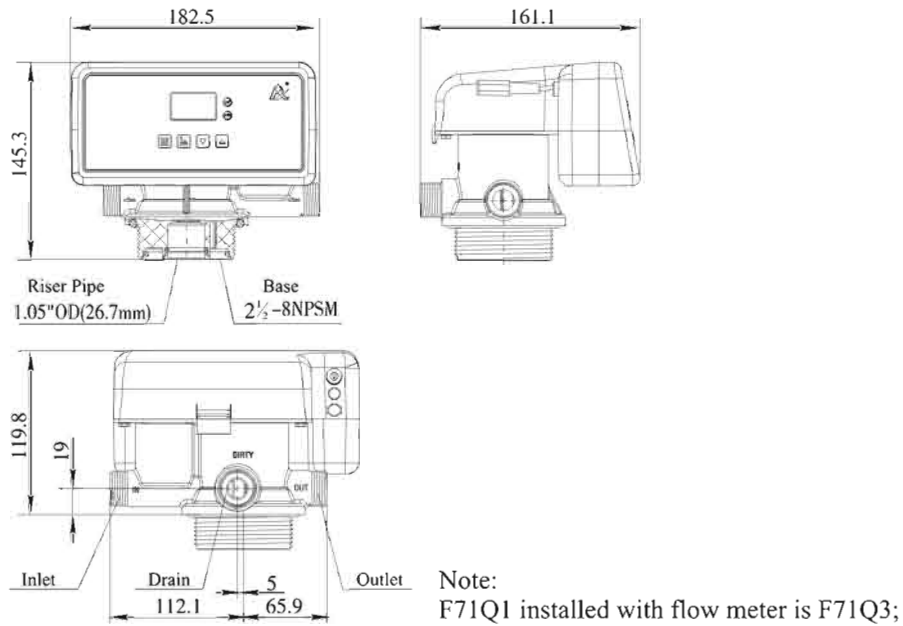

MODEL: F67Q/F71Q/F68Q/F69Q/F116Q/F117Q

F116Q1 structure chart:

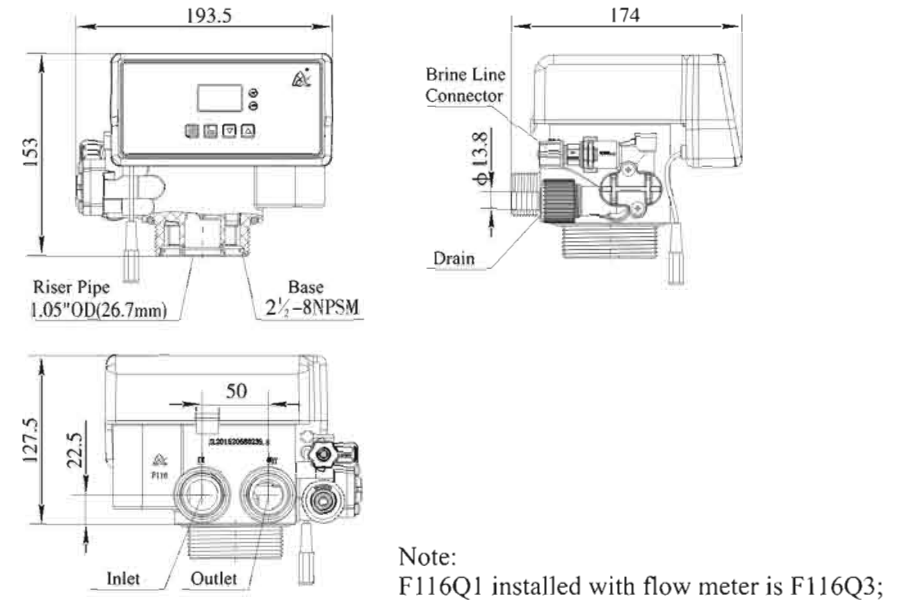

F117Q1 structure chart:

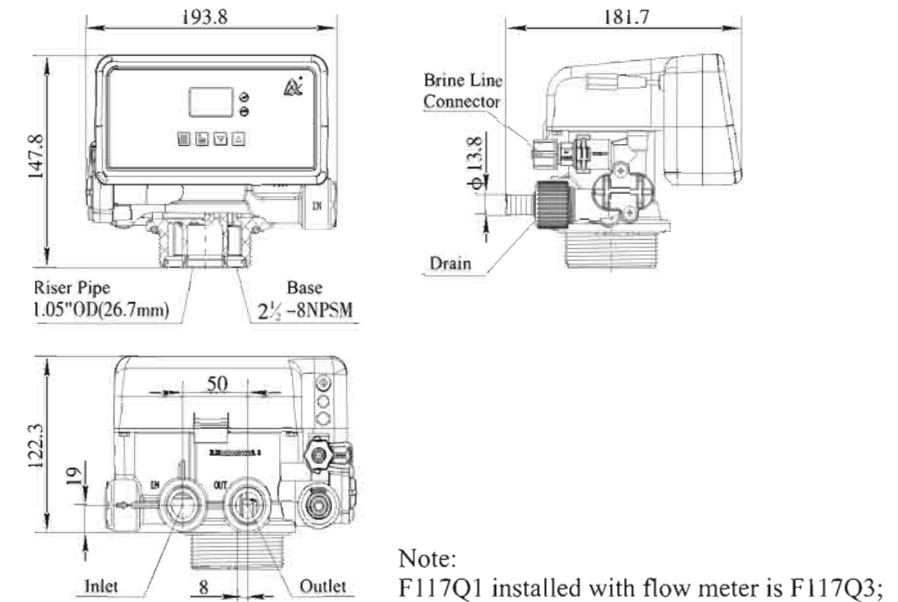

**OD—Outer Diameter, 1.05OD=26.7mm**

**B. Technical Parameters**

F71Q1, F71Q3, F69Q1, F69Q3, F117Q1, F117Q3 control valves are suitable for the power adapter output: DC12V, 1A, other models are suitable for the power adapter output: DC12V, 1.5 A.

Model	Connector Size			Flow Rate m <sup>3</sup> /h	Remark
	Inlet/ Outlet	Drain Line	Brine Line Connector		
F67Q1	G1	G1	/	4 ( @0.3MPa )	Filter, time clock type
F67Q3					Filter, meter type
F71Q1	G3/4	G3/4	/	2 ( @0.3MPa )	Filter, time clock type
F71Q3					Filter, meter type
F68Q1	G1	NPT3/4	G3/8	4 ( @0.3MPa )	Up-flow, time clock type
F68Q3					Up-flow, meter type
F69Q1	G3/4	NPT3/4	G3/8	2 ( @0.3MPa )	Up-flow, time clock type
F69Q3					Up-flow, meter type
F116Q1	G1	NPT3/4	G3/8	4 ( @0.15MPa )	Down-flow, time clock type
F116Q3					Down-flow, meter type
F117Q1	G3/4	NPT3/4	G3/8	2 ( @0.15MPa )	Down-flow, time clock type
F117Q3					Down-flow, meter type

**1.5. Installation**

**A. Installation notice**

Before installation, read all those instructions completely. Then obtain all materials and tools needed for installation.

The installation of product, pipes and circuits should be accomplished by professional to ensure that the product can operate normally.

Perform installation according to relative pipeline regulations and the specification of Water Inlet, Water Outlet, Drain Outlet, Brine Line Connector.

**B. Device location**

- ①The filter or softener should be located close to the drain.
- ②Ensure the unit is installed in enough space for operating and maintenance.
- ③Brine tank needs to be close to softener.
- ④The unit should be kept away from the heater, and not be exposed outdoor. Sunshine or rain will cause the system damage.
- ⑤Please avoid to install the system in one acid/alkaline, Magnetic or strong vibration circumstance, because above factors will cause the system disorder.

⑥Do not install the filter or softener, drain pipeline in circumstance which temperature may drop below 5℃, or above 50℃.

⑦The system should be installed in a place where there will be the minimum loss in case of water leakage.

**C. Pipeline installation (F116Q3 as example)**

①Install control valve

a.As the Figure 1-1 shows, select the riser pipe with 26.7mm OD, glue the riser pipe to the bottom strainer and put it into the mineral tank, cut off the exceeding tube out of tank top opening. Plug the riser tube in case of mineral entering.

b.Fill a stipulated amount of resin to the tank.

c.Screw the top strainer into the control valve.

d.Insert the riser tube into control valve and screw tight control valve.

**Notice:**

- The length of riser tube should be neither higher 2mm nor 5mm lower than the tank top opening, and its top end should be rounded to avoid damage of O-ring inside the valve.
- Avoid floccules substance together with resin fill in the mineral tank.
- Avoid O-ring inside control valve falling out while rotate it on the tank.

②Install animated connector

As Figure1-2 shows, put the sealing ring into nut of animated connector, and screw in water inlet.

③Install flow meter

As Figure1-2 shows, put the seal ring into nut of flow meter, screw in water outlet; insert the sensor into flow meter.

④Pipeline connection

a. As Figure1-3 shows, install a pressure gauge in water inlet.

b. Install valve A, B, C and D in the intermediate pipeline, inlet and outlet. valve D is a sampling valve. (Or adopt F70A/F70C bypass valve).

c. Install a check valve in water outlet.

d. Inlet pipeline should be in parallel with outlet pipeline. Support inlet and outlet pipeline with fixed holder.

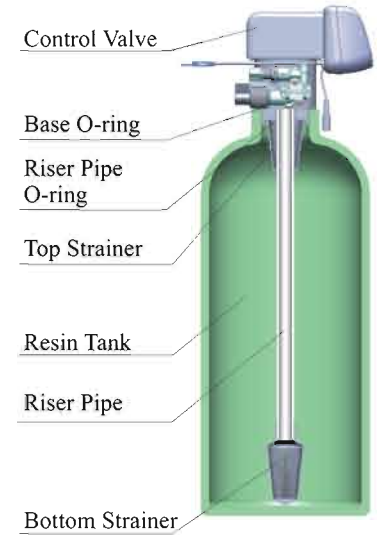

Figure1-1

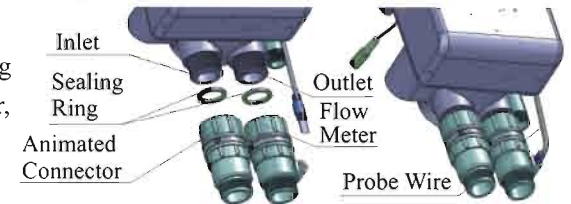

Figure1-2

MODEL: F67Q/F71Q/F68Q/F69Q/F116Q/F117Q

**Note:**

● If the water outlet or water tank is installed higher than control valve or parallel interlock system with multi-outlets, a liquid level controller must be installed in brine tank, or install a check valve in water outlet. Or else, the water in water outlet or water tank will flow backwards into brine tank when backwash. The water in water outlet or water tank will flow backwards into drain when brine refill—Suitable for F68Q/F69Q/F116Q/F117Q.

● If use a soldered copper to install inlet/outlet pipes, do all sweat soldering before connecting pipes to the valve. Torch heat will damage plastic parts.

● When turning threaded pipe fittings onto plastic fitting, do not use excessive force to make threads misaligned or break valve.

● If the valve belongs to time clock type, there is no step ② and ③.

⑤ Install drain pipeline

a. As the Figure 1-4 shows, slide the drain hose connector into drain outlet.

b. Locate the drain hose well as the Figure 1-4 show.

**Note:**

● Control valve should be higher than drain outlet, and not far from the drain hose. If drain outlet higher than control valve, a check valve must be installed in drain outlet. Or else, the waste water will flow backwards into water outlet when brine refill—Suitable for F68Q / F69Q / F116Q / F117Q.

● Be sure not to connect drain with sewer, and leave a certain space between them, avoid waste water being absorbed to the water treatment equipment, such as showed in the Figure1-4.

⑥ Connect brine tube

a. As Figure 1-5 shows, slide 3/8" brine tube hose connector over end of brine tube.

b. Insert tube bushing into the end of brine tube.

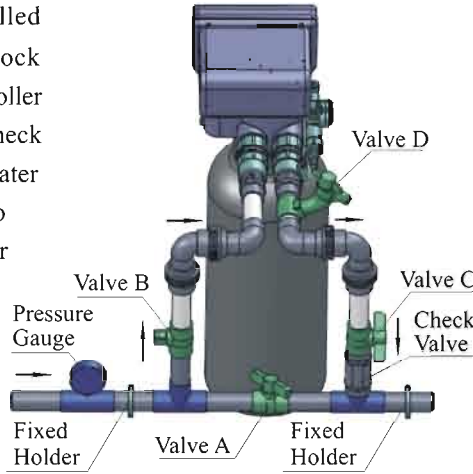

Figure1-3

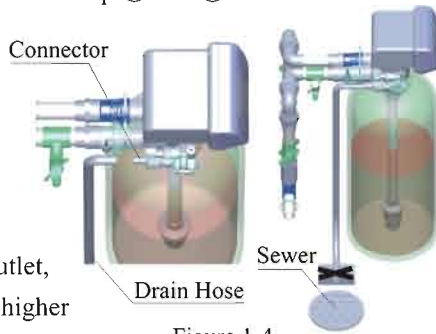

Figure 1-4

MODEL: F67Q/F71Q/F68Q/F69Q/F116Q/F117Q

c. Tighten nut onto brine line connector.

d. Connect the other end of brine tube with the brine tank. (The liquid level controller and air-blocker should be installed in the brine tank.)

Remark: The brine tube and drain pipeline should not be bended or plugged.

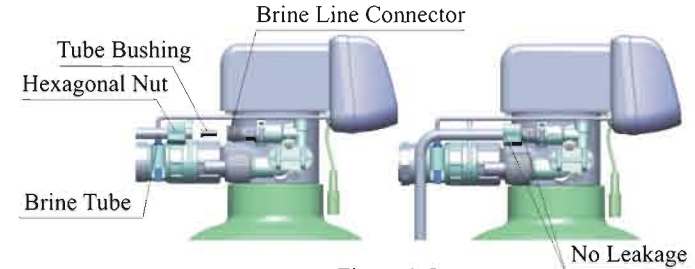
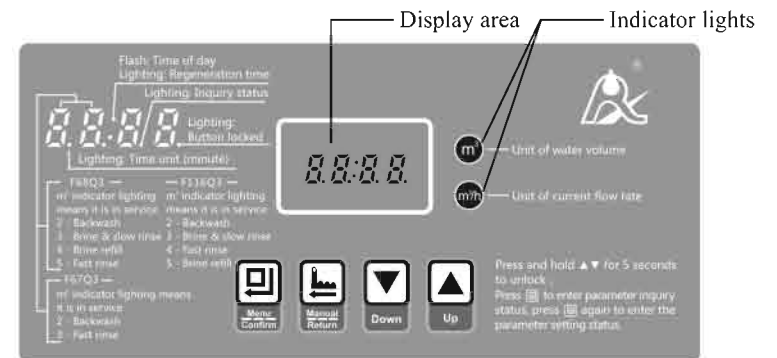
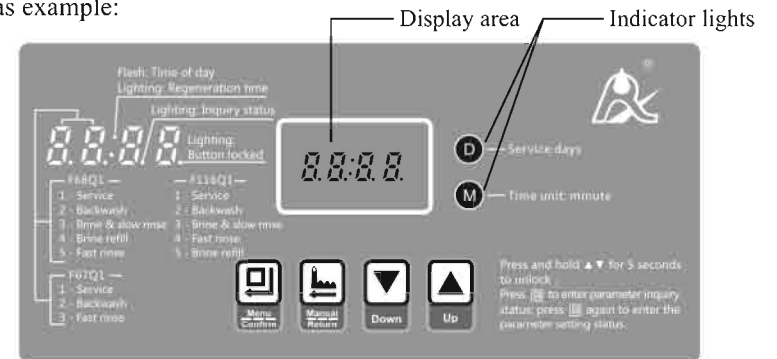

Figure 1-5

## 2. Basic Setting & Usage

### 2.1. The Function of PC Board

Take time clock type valves F67Q1/F68Q1/F116Q1 and meter type valves F67Q3/F68Q3 /F116Q3 as example:





A.Button lock indicator

●When the fourth decimal point of digital tube turns on, it indicates the buttons are locked. At this moment, pressing any single button will not work (No operation in one minute, the fourth decimal point of the digital tube will light on and lock the buttons).

●Solution: Press and hold both “▼” and “▲” for 5 seconds until the decimal point lights off.

B.Time of day indicator

●When “:” flashes, it indicates the time of day.

C.Program mode indicator

●The third decimal point of digital tube turns on, it indicates the inquiry mode. Use “▼” or “▲” to view all values.

●The third decimal point of digital tube flashes, it indicates the set mode. Use “▼” or “▲” to adjust all values.

D. “☐” Menu/Confirm button

●In menu mode, press “☐” to enter inquiry mode, the third decimal point of digital tube turns on.

●In inquiry mode, press “☐” and to enter set mode. Parameter to be set flashes.

●Press “☐” after all program are set successful, and return to inquiry mode.

E. “☐” Manual/Return button

●In menu mode, press “☐”, it can proceed to next step. (Example: press “☐” in service status, it will start regeneration cycles/washing instantly if the outlet water is unqualified; Press “☐” while it is in regeneration/washing status, it will end regeneration/washing and go to the next status at once.)

F. “▼” Up and “▲” Down

●In program inquiry mode, press “▼” or “▲” to view all values.

●In program set mode, press “▼” or “▲” to adjust values.

●Press and hold both “▼” and “▲” for 5 seconds to unlock the buttons.

●In program set mode, press “☐” to return to program inquiry mode; in program inquiry mode, press “☐” to return to menu mode.

●Press “☐” while adjusting the values, then it will return to program inquiry mode directly without saving values. Press “☐”, it will save the values and return to program inquiry mode.

2.2. Basic Setting & Usage (F116Q3 A-01 as example)

A. Parameter specifications

Function	Indicator	Factory Default	Parameter Set Range	Instruction
Time of Day	“:”Flashes	Random	00:00~23:59	When use, enquiry and set, the time of day “:” flashes.
Regeneration Time	“:”Lighting	02:00	00:00~23:59	Regeneration time; “:” lighting.
Control Mode	/	A-01	A-01	Meter Delayed: Regenerate will not start although the available volume of treated water drops to zero (0) until at the regeneration time.
			A-02	Meter Immediate: Regenerate immediately when the available volume of treated water drops to zero(0).
Water Treatment Capacity	m <sup>3</sup>	10.00m <sup>3</sup>	0~99.99 m <sup>3</sup>	Water treatment capacity in one circle (m <sup>3</sup> )
Backwash Time	2-	10	0~99	Backwash time (minute)
Brine & Slow Rinse Time	3-	60	0~99	Brine & slow rinse time (minute)
Fast Rinse Time	4-	10	0~99	Fast rinse time (minute)
Brine Refill Time	5-	05	0~99	Brine refill time (minute)
Maximum Interval Regeneration Days	H-30	30	0~40	Regenerate at the regeneration time even though the available volume of treated water does not drop to zero (0).
Output Control Mode	b-01	01	01 or 02	b-01: Signal turn on when regeneration started and shut off at the end of regeneration. b-02: Signal available only in intervals of each status.

B.Process Display (Take A-01 as example)

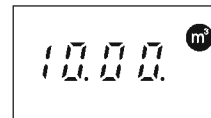

Figure A

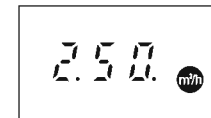

Figure B

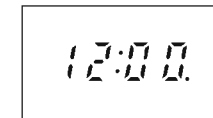

Figure C

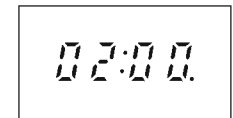

Figure D

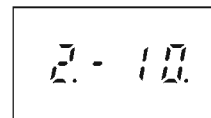

Figure E

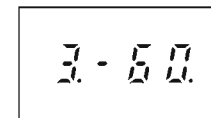

Figure F

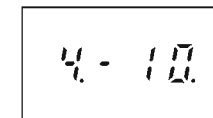

Figure G

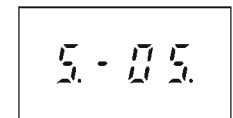



Figure H









Illustration:









- In Service status, the figure shows A/B/C/D. Figure C shows time of day, the middle “:” flashes. Figure D shows regeneration time, the middle “:” turns on;
- In Backwash status, it shows as figure E/C; In Brine & Slow Rinse status, it shows as F/C; In Fast Rinse status, it shows as figure G/C; In Brine Refill status, it shows as figure H/C. In each status, every figure shows 15 seconds.
- Above displays are taking the Meter Type F116Q3 A-01 for example. For the Time Clock Type, it shows the rest days, such as 1-03D.
- The display screen will only show “-00-” when the motor is running.
- The time of day figure flashes continuously, such as “12:12” flashes, which indicates long outage of power. It reminds to reset the time of day.
- The display will show the error code, such as “-E1-” when the system is in error.
- F117Q/F116Q working process: Service → Backwash → Brine & Slow Rinse → Fast Rinse → Brine Refill → Service.
- F68Q/F69Q working process: Service → Backwash → Brine & Slow Rinse → Brine Refill → Fast Rinse → Service.
- F67Q/F71Q working process: Service → Backwash → Fast Rinse → Service.

C.Usage

After the accomplishment of installation, parameter setting and trial running by the professional, the valve can be put into use. In order to ensure that the quality of outlet water can reach the requirements, the user should complete the below work:

- ① Add the salt for regeneration in time to ensure the solid is always available in brine tank. Only clean softening salt can be added to the brine tank, at least 99.5% pure. It is forbidden to use fine salt and iodized salt.
- ② Test the outlet water and raw water hardness at regular intervals. When the outlet water hardness is unqualified, please press the “” and the valve will temporarily regenerate again (It will not affect the original set operation cycle)
- ③ When the feed water hardness changes a lot, you can adjust the water treatment capacity as below:

Press and hold both “” and “” for 5 seconds to unlock the buttons. Press “”, the third decimal point of digital tube lights on, then press “” to choose the water treatment capacity, the digital area will show the given water treatment capacity, such as 10.00m<sup>3</sup>. Press “” again, the water treatment capacity “10.00” flashes, then press “” to reset the value. Press “” twice and hear a sound “Di”, the adjustment finished. Press “” exit and turn back to the service status.

- ④ For A-01 control mode (Delayed regeneration type), please pay attention whether the time is current or not. If the time is not right, you can adjust as below: After unlocking the buttons, press “”, the third decimal point of digital tube lights on. Then press “”, the “:” and hour value flash. Press “” or “” continuously to reset the hour value; Press “” again, “:” and minute value flash. Press “” or “” continuously, reset the minute value; Press “” and hear a sound “Di”, the adjustment finished. Press “” exit and turn back to the service status.

**The regeneration parameters have been set when control valve left the factory. Generally, it does not need resetting. If you want to inquire and modify the settings, you can refer to the professional application specifications.**

### 3. Applications

#### 3.1. Flow Chart

##### A. Filter

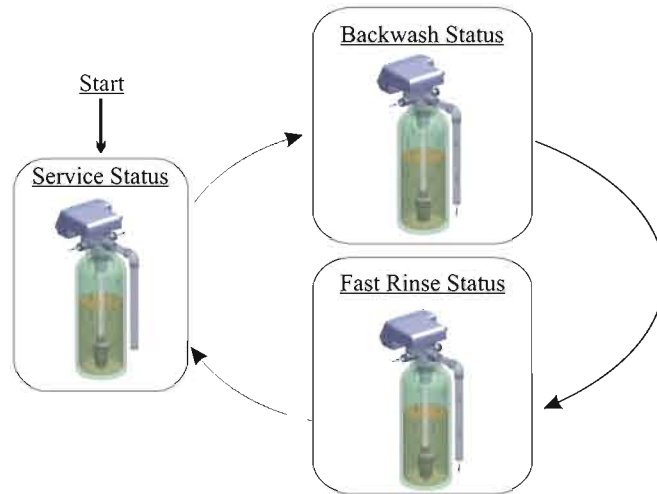

##### B. Softener

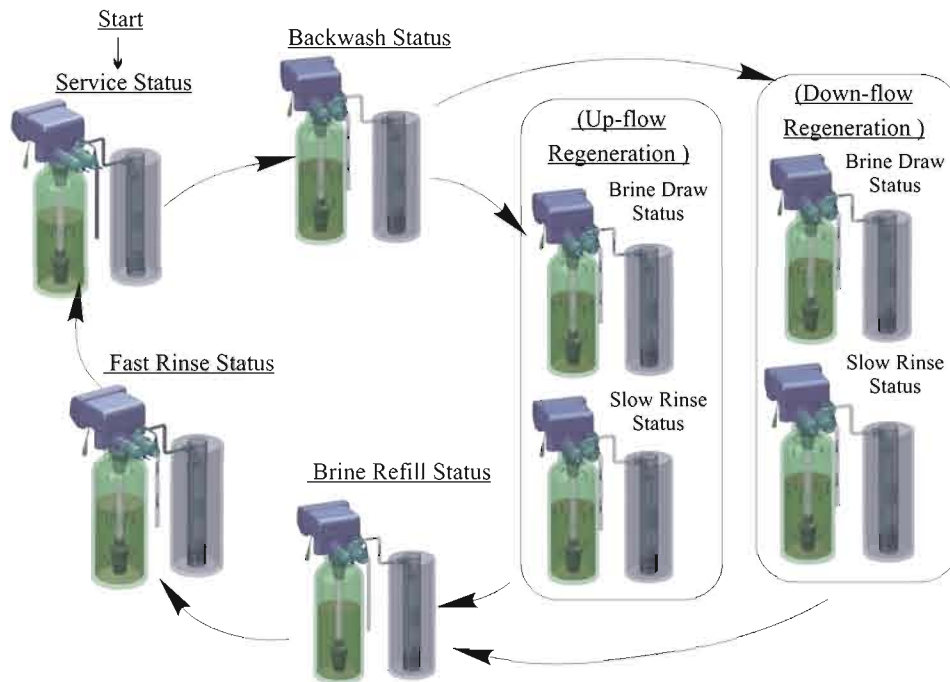

#### Remark:

F68Q, F69Q working process: Service → Backwash → Brine & Slow Rinse (Up-flow Regeneration) → Brine Refill → Fast Rinse → Service.

F117Q, F116Q working process: Service → Backwash → Brine & Slow Rinse (Down-flow Regeneration) → Fast Rinse → Brine Refill → Service.

#### 3.2. The Function and Connection of PC Board

Opening the front cover of control valve, you will see the main control board and connection parts as below:

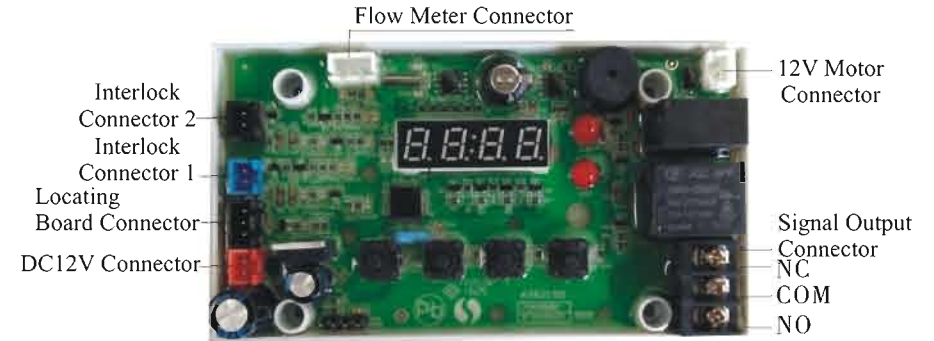

The main functions on main control board:

Function	Application	Explanation
Signal output connector b-01	Outlet solenoid valve	Used in strictly requirements regarding no hard water flowing from outlet or control the liquid level in water tank.
	Inlet pump	Increase pressure for regeneration or washing. Use the liquid level controller to control inlet pump to ensure there is water in tank.
Signal output connector b-02	Inlet solenoid valve or inlet pump	When inlet pressure is high, it needs to close water inlet to protect motor when valve is rotating.
Interlock connector	To ensure only one control valve in regeneration or washing in system.	Use in RO Pre-treatment, water supply together but regeneration in turn. Second grade ion exchange equipment, etc.

#### A. Signal Output Connector

1) Control Solenoid Valve (Set as b-01)

① Solenoid Valve on Outlet Controls Water Level in Brine Tank.

**Instruction:** If system requires no hard water to flow from outlet in regeneration cycle (Mainly for no hard water flows out when valve is switching or valve in backwash or brine drawing status), a solenoid valve could be installed on outlet, the wiring refers to Figure 3-1.

**MODEL: F67Q/F71Q/F68Q/F69Q/F116Q/F117Q**

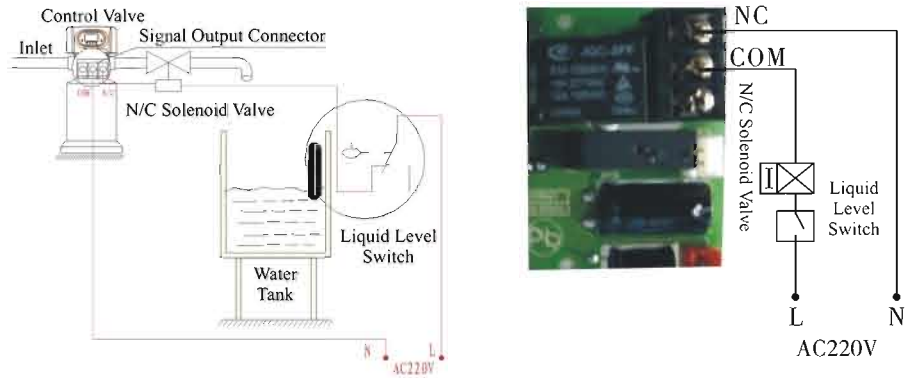

Figure 3-1 Wiring of Solenoid Valve on Outlet

**Function:**

When valve in service status, if soft water tank is shortage of water, solenoid valve will open to supply soft water, but if water tank has enough water, solenoid valve will close, so no soft water will be supplied to the tank.

When the valve is in backwash or other regeneration status, there is no signal output. So, solenoid valve will close, and no raw water flows into soft water tank.

② Solenoid Valve on Inlet (Set as b-02)

**Instruction:** When inlet pressure exceeds 0.6MPa, install a solenoid valve on inlet. Control mode is b-02. Pressure will be relieved when valve is switching, the wiring refers to Figure 3-2. As Figure 3-3 shows, it also can use the pressure relief connector to work.

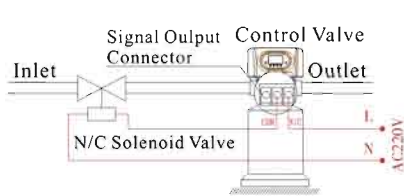

Figure 3-2 Wiring of Solenoid Valve on Inlet

**Function:**

When inlet pressure is high, install a solenoid valve on inlet to ensure valve switching properly. When valve is exactly in status of Service, Backwash, Brine & Slow Rinse, Fast Rinse and Brine Refill, solenoid valve is open. When valve is switching, solenoid valve is closed, no water flows into valve to ensure valve switching properly. It could prevent the problem of mixing water and water hammer.

Use interlock cable to realize valves in parallel or series connection in the same system which is suited for RO pretreatment system or second grade Na<sup>+</sup> system. The wiring refers to Figure 3-4:

**MODEL: F67Q/F71Q/F68Q/F69Q/F116Q/F117Q**

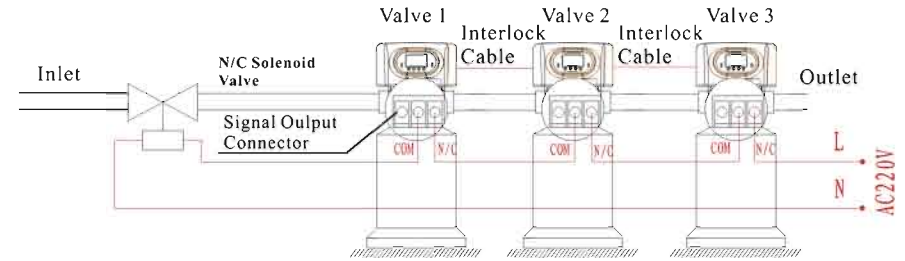

Figure 3-4 Wiring of Solenoid Valve on Inlet

2) Liquid Level Controller Controls Inlet Pump (Two-phase motor) (Set as b-01)

**Instruction:** For the system using well or middle-tank supplying water, switch of liquid level controller and valve together control pump opening or closing. The wiring refers to Figure 3-5:

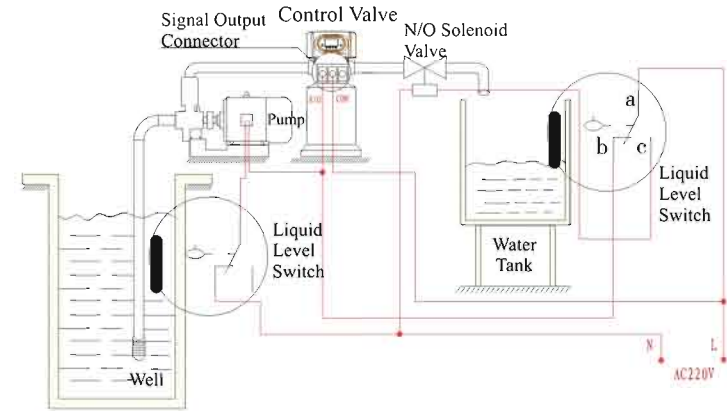

Figure 3-5 Wiring of Liquid Level Switch Control Inlet Pump

**Function:**

When valve is in service status, if water tank is short of water, pump starts working. If water tank has enough water, the switch of liquid level controller is closed, so pump does not work.

When valve is in regeneration cycle, no matter what water condition is in water tank, open the pump to make sure there is water on inlet. As Runxin valve no water passes outlet in regeneration cycle, it ensures no water fill into brine tank.

A liquid switch at the top opening well or in middle water tank in RO system protects pump from working without water in case of out of raw water.

3) Liquid Level Switch in Water Tank Controls Inlet pump (Three-phase motor, Figure 3-6) (Set as b-01)

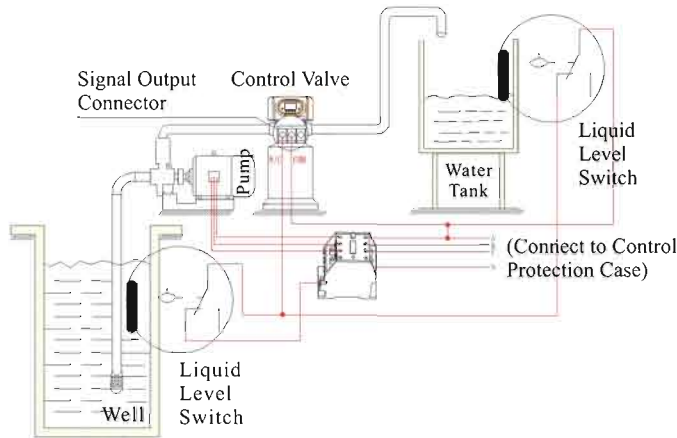

Figure 3-6 Wiring of Liquid Level Switch in Water Tank Controls Inlet Pump

4) Control Inlet Booster Pump (Set as b-01 or as b-02)

**Instruction:** If inlet water pressure is less than 0.15MPa, which makes rinse drawing difficult, a booster pump is suggested to be installed on inlet. Set Control mode as b-01. When system in regeneration cycle, booster pump is open, the wiring refers to Figure 3-7. If the booster pump current is bigger than 5A, system needs to install a contactor, the wiring refers to Figure3-8.

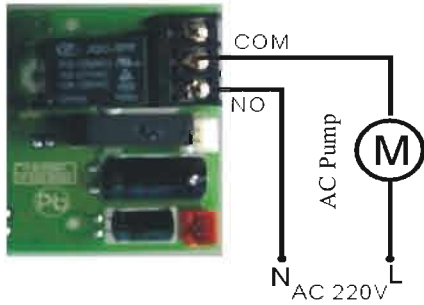

Figure 3-7 Wiring of Booster Pump on Inlet

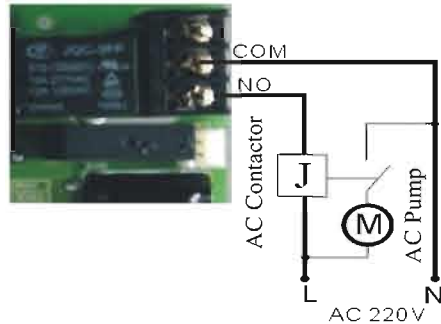

Figure 3-8 Wiring of Booster Pump on Inlet

**B. Interlock**

**Instruction:**

In the parallel water treatment system, it ensures only one valve in regeneration or washing status and (n-1) valves in service, that is, realizing the function of supplying water simultaneously and regenerating individually, the wiring refers to Figure 3-9.

In the series water treatment system (Second grade Na+ Exchanger or RO pre-treatment system), it ensures only one valve in regeneration or washing status and there is water in service.

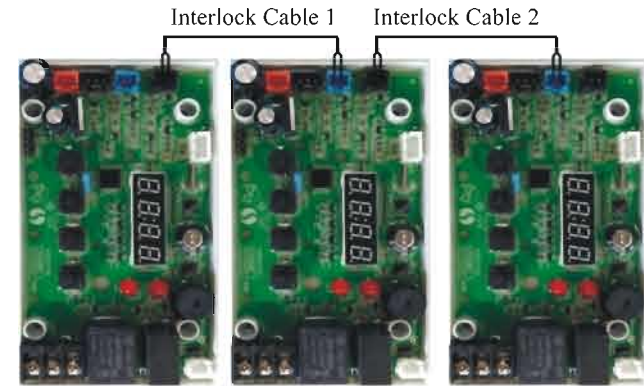

Figure 3-9 Interlock

**Note:**

A) The interlock cable connector need to be connected with the same color of the interlock connector on the main board.

B) The above figure of interlock cable connection takes three valves interlocking as an example.

Use interlock cable to connect the black socket of one valve with the blue socket of another valve in series.

One system with several valves, if interlock cable is disconnected, the system is divided into two individual system.

**C. Double (Multiple) Valves, Supply Water Simultaneously and Regenerate Separately**

It only needs to connect the two or more valves by interlock cables. The wiring refers to Figure3-10.

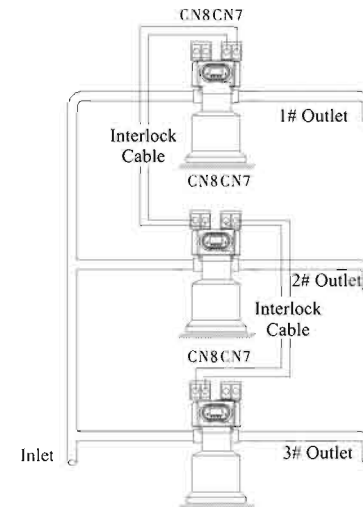

Figure 3-10 Supply Water at Simultaneously and Regenerate Separately



3.3 System Configuration and Flow Rate Curve

A. Product Configuration

Commonly used tank size and filter material volume configuration for filter system.

Tank Size	Volume of Filter Material	Carbon Filter		Sand Filter	
		Filtering Flow Rate	Backwash Flow Rate	Filtering Flow Rate	Backwash Flow Rate
mm	L	m <sup>3</sup> /h	m <sup>3</sup> /h	m <sup>3</sup> /h	m <sup>3</sup> /h
φ 180 × 1130	16	0.3	0.9	0.6	1.3
φ 205 × 1300	25	0.4	1.1	0.8	1.7
φ 255 × 1390	40	0.6	1.7	1.2	2.6
φ 300 × 1390	60	0.8	2.5	1.7	3.8
φ 355 × 1670	100	1.2	3.4	2.4	5.2
φ 400 × 1670	120	1.5	4.5	3.1	6.8

**Attention:** the filtering flow rate of carbon filter is calculated based on the 12m/h operation rate; the backwash flow rate is calculated based on the 10L/(m<sup>2</sup>\*s) backwash intensity; the filtering flow rate of sand filter is calculated based on the 25m/h operation rate; the backwash flow rate is calculated based on the 15L/(m<sup>2</sup>\*s) backwash intensity.

Commonly used tank size, resin volume, brine tank and injector configuration for softener system.

F116Q, F117Q:

Tank Size (mm)	Resin Volume (L)	Flow Rate (t/h)	Brine Tank Size (mm)	The Minimum Salt Consumption for Regeneration (Kg)	Injector Model	Control Valve Model
φ 180 × 1130	16	0.5	φ 250 × 520	2.40	6303	F117Q
φ 205 × 1300	25	0.7	φ 390 × 810	4.00		
φ 255 × 1390	40	1.2	φ 390 × 810	6.00		
φ 300 × 1650	60	1.8	φ 450 × 940	9.00	6307	F117Q
φ 355 × 1650	100	2.5	φ 500 × 1060	15.00		
φ 255 × 1390	40	1.2	φ 390 × 810	6.00	6306	F116Q
φ 300 × 1650	60	1.8	φ 450 × 940	9.00		
φ 355 × 1650	100	2.5	φ 500 × 1060	15.00	6308	F116Q
φ 400 × 1650	120	3.5	φ 550 × 1160	18.00		
φ 450 × 1650	150	4.5	φ 550 × 1160	22.50	6309	

F68Q, F69Q:

Tank Size (mm)	Resin Volume (L)	Flow Rate (t/h)	Brine Tank Size (mm)	The Minimum Salt Consumption for Regeneration (Kg)	Injector Model	Control Valve Model
φ 205 × 1300	25	0.7	φ 390 × 810	4.00	6301	F69Q
φ 255 × 1390	40	1.2	φ 390 × 810	6.00	6303	
φ 300 × 1650	60	1.8	φ 450 × 940	9.00	6304	
φ 355 × 1650	100	2.5	φ 500 × 1060	15.00	6306	F68Q
φ 400 × 1650	120	3.5	φ 550 × 1160	18.00	6307	
φ 450 × 1650	150	4.5	φ 550 × 1160	22.50	6308	

**Attention:** The flow rate calculation is based on linear velocity 25m/h; the minimum salt consumption for regeneration calculation is based on salt consumption 150g/L (Resin).

B. Flow Rate Characteristic

1) Pressure-flow rate curve

F67Q

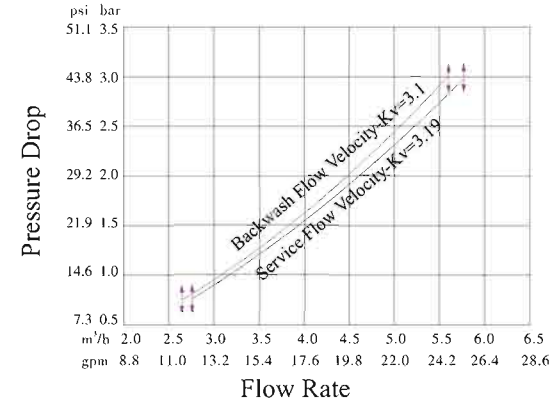

F68Q

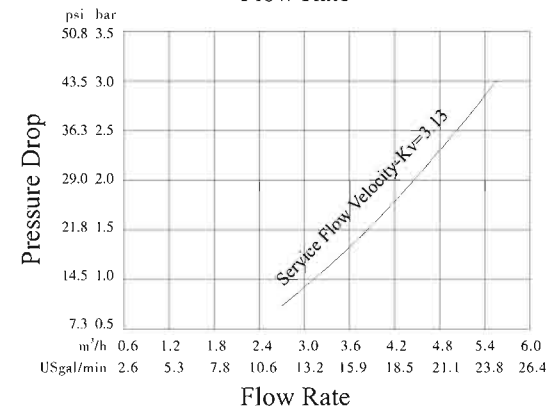

MODEL: F67Q/F71Q/F68Q/F69Q/F116Q/F117Q

F69Q

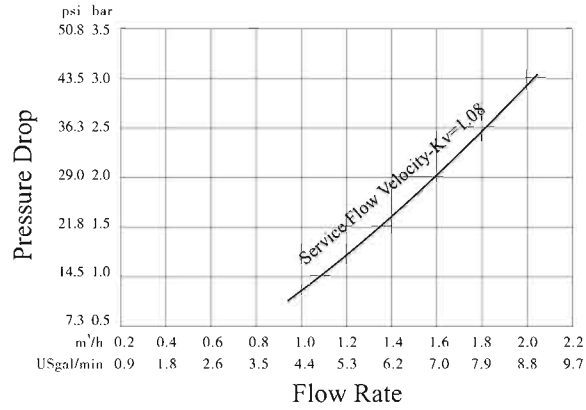

F71Q

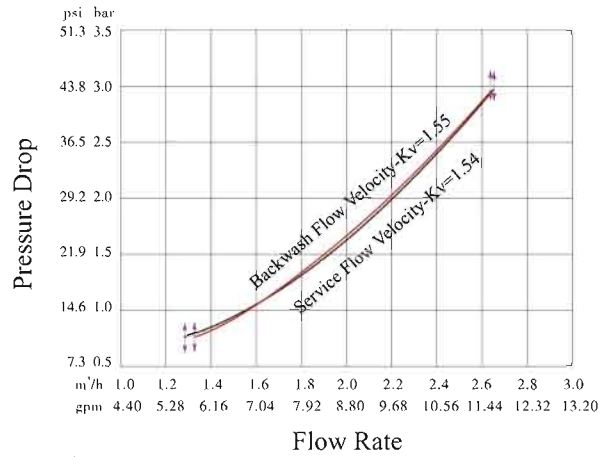

F116Q

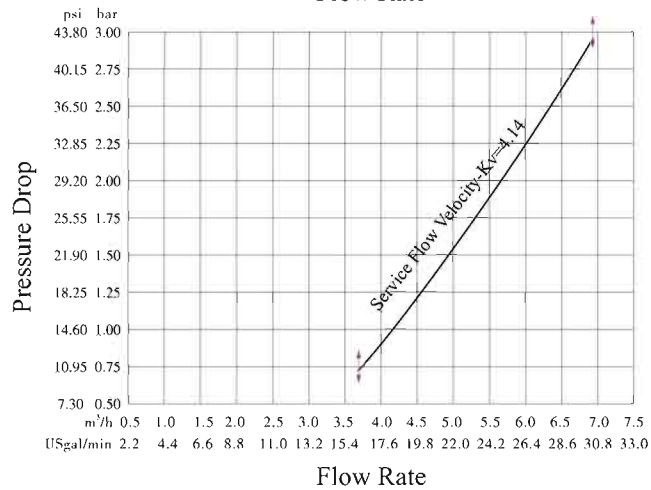

MODEL: F67Q/F71Q/F68Q/F69Q/F116Q/F117Q

F117Q

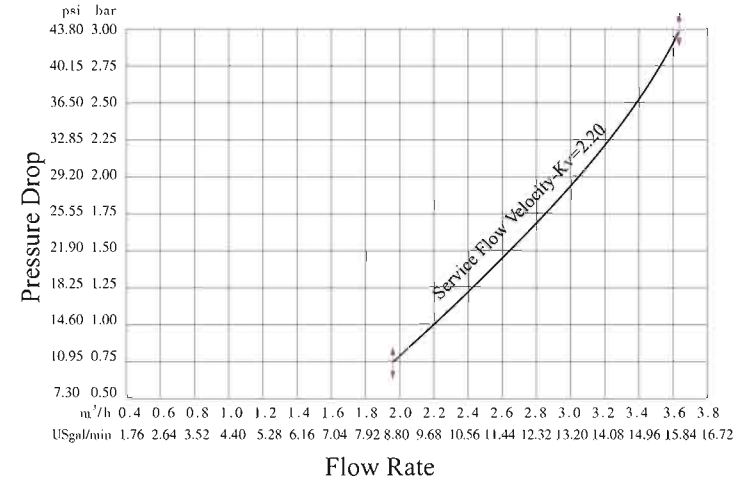

2) Injector parameter table

F68Q, F69Q:

Inlet Pressure	Draw Rate(L/M)					
	F69Q			F68Q		
MPa	6301 Coffee	6303 Yellow	6304 Blue	6306 Black	6307 Purple	6308 Red
0.15	1.47	2.30	2.80	4.03	4.74	5.24
0.20	1.51	2.60	3.30	4.67	5.46	5.99
0.25	1.59	2.92	3.71	5.07	6.11	6.69
0.30	1.76	3.20	4.08	5.59	6.60	7.32
0.35	1.88	3.45	4.33	6.06	7.03	7.79
0.40	2.00	3.70	4.67	6.44	7.40	8.11

**MODEL: F67Q/F71Q/F68Q/F69Q/F116Q/F117Q**

F116Q, F117Q:

Inlet Pressure	Draw Rate(L/M)					
	F117Q			F116Q		
MPa	6303 Yellow	6304 Blue	6307 Purple	6306 Black	6308 Red	6309 Green
0.15	1.95	2.37	3.08	3.73	4.78	5.77
0.20	2.28	2.70	3.52	4.27	5.58	6.68
0.25	2.52	3.02	3.88	4.78	6.28	7.37
0.30	2.75	3.33	4.27	5.27	6.80	8.10
0.35	2.95	3.55	4.63	5.67	7.37	9.70
0.40	3.15	3.75	4.92	6.07	7.65	9.18

**3) Configuration for Standard Injector and Drain Line Flow Control**

F68Q, F69Q:

Tank Dia. mm	Injector Mode	Injector Color	Draw Rate	Slow Rinse	BLFC Optional	DLFC	Back-wash/ Fast Rinse	Control Valve Model
			L/m	L/m			L/m	
205	6301	Coffee	1.76	0.92	8468076, 8468075, 8468057, 8468056, 8468052 (Standard).	8468042	7.50	F69Q
255	6303	Yellow	3.20	2.01	8468076, 8468075, 8468057, 8468056, 8468052, 8468053 (Standard).	8468061	12.17	
300	6304	Blue	4.08	2.66	8468076, 8468075, 8468057, 8468056, 8468052, 8468053 (Standard).	8468077	17.17	
355	6306	Black	5.59	3.33	8468076, 8468075, 8468057, 8468056, 8468052, 8468053, 8468054, 8468055 (Standard).	8468062	24.83	F68Q
400	6307	Purple	6.60	4.05	8468076, 8468075, 8468057, 8468056, 8468052, 8468053, 8468054, 8468055 (Standard).	No DLFC	33.17	
450	6308	Red	7.32	4.42	8468076, 8468075, 8468057, 8468056, 8468052, 8468053, 8468054, 8468055 (Standard).	No DLFC	33.17	

**MODEL: F67Q/F71Q/F68Q/F69Q/F116Q/F117Q**

F116Q, F117Q:

Tank Dia. mm	Injector Mode	Injector Color	Draw Rate	Slow Rinse	BLFC Optional	DLFC	Back-wash/ Fast Rinse	Control Valve Model
			L/m	L/m			L/m	
175~205	6303	Yellow	2.75	1.66	8468076, 8468075, 8468057, 8468056, 8468052, 8468053 (Standard).	8468042	7.33	F117Q
225~255	6304	Blue	3.33	2.18	8468076, 8468075, 8468057, 8468056, 8468052, 8468053 (Standard).	8468060	8.83	
300~355	6307	Purple	4.27	3.03	8468076, 8468075, 8468057, 8468056, 8468052, 8468053, 8468054, 8468055 (Standard).	8468062	16.83	
255~300	6306	Black	5.27	3.31	8468076, 8468075, 8468057, 8468056, 8468052, 8468053, 8468054 (Standard).	8468077	19	F116Q
325~355	6308	Red	6.80	4.28	8468076, 8468075, 8468057, 8468056, 8468052, 8468053, 8468054, 8468055 (Standard).	8468062	24.83	
400~450	6309	Green	8.10	5.23	8468076, 8468075, 8468057, 8468056, 8468052, 8468053, 8468054, 8468055 (Standard).	No DLFC	31.33	

**Remark: Above data for the product configurations and relevant characteristics are only for reference. When put in practice, please subject to the different requirements of raw water hardness and application.**

**4) Configuration for Brine Line Flow Control**

F68Q, F69Q:

No.	8468076	8468075	8468057	8468056	8468052	8468053	8468054	8468055
Flow Rate L/m	0.31	0.70	1.03	1.52	2.06	3.25	5.41	6.67

F116Q, F117Q:

No.	8468076	8468075	8468057	8468056	8468052	8468053	8468054	8468055
Flow Rate L/m	0.30	0.58	0.68	1.32	1.55	2.95	5.00	5.67



### 3.4 Parameter settlement

#### ①Service Time T1

Water Treatment Capacity:

$$Q = V_R \times K \div Y_D \quad (\text{m}^3)$$

- Hardness of Inlet Water, mmol/L.
- Exchange factor, mmol/L, 400~1000. Down-flow regeneration, take 400~750; Up-flow regeneration, take 450~1000. If the inlet water hardness is higher, the factor is smaller.
- Resin volume, m<sup>3</sup>.

By hours:  $T1 = Q \div Q_h$  (Hour)

- Average water consumption per hour (m<sup>3</sup>/h)
- Water treatment capacity (m<sup>3</sup>)

By days:  $T1 = Q \div Q_d$  (Day)

- Average water consumption per day (m<sup>3</sup>/d)
- Water treatment capacity (m<sup>3</sup>)

#### ②Backwash Time T2

Generally, it is suggested to set 10~15 minutes. The higher the turbidity is, the longer backwash time shall be set. However, if the turbidity is more than 5FTU, it is better to install a filter in front of the exchanger.

#### ③Brine & Slow Rinse Time T3

$$T3 = (40 \sim 50) \times H_r \quad (\text{min})$$

Generally,  $T3 = 45H_r$  (min)

In this formula,  $H_r$  — The height of the resin in the exchange tank (m)

#### ④Brine Tank Refill Time T4

Down flow regeneration:  $T4 = 0.45 \times V_R \div \text{Brine refill speed}$

Up flow regeneration:  $T4 = 0.34 \times V_R \div \text{Brine refill speed}$

In this formula,  $V_R$  — Resin volume (m<sup>3</sup>)

The brine tank brine refill speed is related to the inlet pressure. The real refill time should be 1 to 2 minutes longer than the calculated time in order to refill enough water in the brine tank. (The brine tank should be equipped with liquid level controller)

#### ⑤Fast Rinse Time T5

$$T5 = 12 \times H_r \quad (\text{min})$$

Generally, the water for fast rinse is 3~6 times of resin volume, and fast rinse time can be ranged from 10~16 minutes. But it should meet the requirements of qualified outlet water.

#### ⑥Exchange Factor

$$\text{Exchange factor} = E / (k \times 1000)$$

In this formula, E — Resin working exchange capability (mol/m<sup>3</sup>), it is related to the quality of resin. Down-flow regeneration, take 800~900. Up-flow regeneration, take 900~1200.

K — Security factor, always take 1.2~2. It is related to the hardness of inlet water: the higher the hardness is, the bigger the K is.

#### ⑦Set Interval Backwash Times (Only for F68Q/F69Q)

When the turbidity of raw water is higher, the interval backwash time could be set F-00. That is to say, backwash in each regeneration; when the turbidity is lower, the interval backwash time could be set F-01 (or other number value), it is to say that backwash in every two regeneration. Thus, Service → Brine & Slow rinse → Brine refill → Fast rinse → Service → Backwash → Brine & Slow rinse → Brine refill → Fast rinse.

⑧Regeneration Time: The whole cycle for regeneration is about two hours. Please try to set up the regeneration time when you don't need to use water according to the actual situation.

The above calculation of parameters for each step is only for reference, the actual proper time will be determined after adjusting by water exchanger supplier. This calculation procedure of softener is only for industrial application; it is not suitable for small softener in residential application.

### 3.5 Parameter Enquiry and Setting

#### A. Parameter Enquiry

When the fourth decimal point of the digital tube keeps turning on, press and hold both “▼” and “▲” for 5 seconds to unlock the button; then press “☐” until the third decimal point of digital tube turned on, enter to program inquiry mode. Press “▼” or “▲” to view each value according to the following process. (Press “⏏” to exit.)

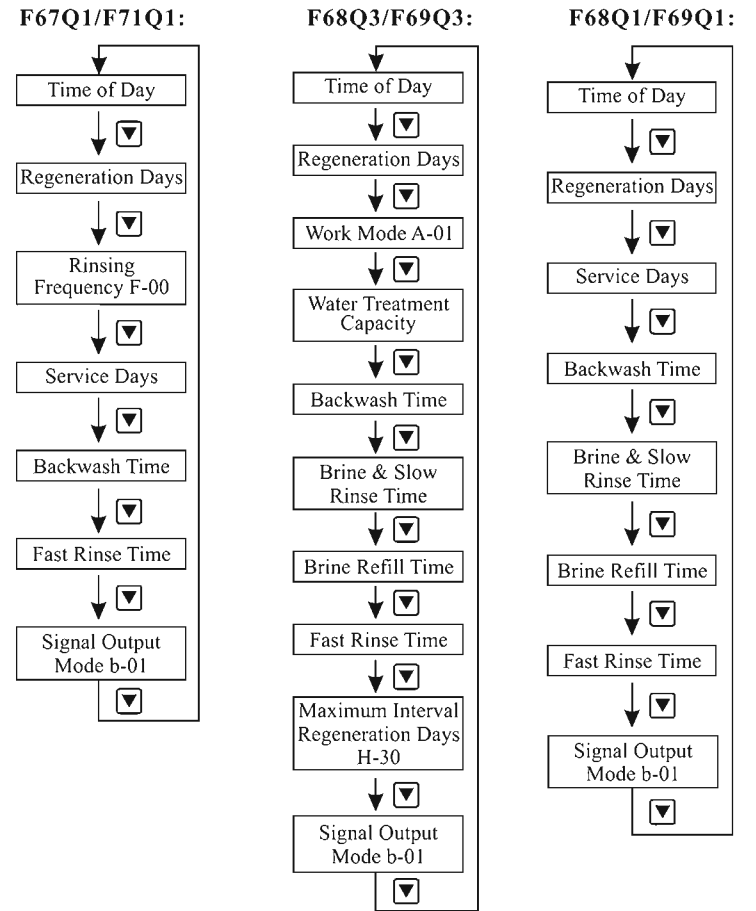
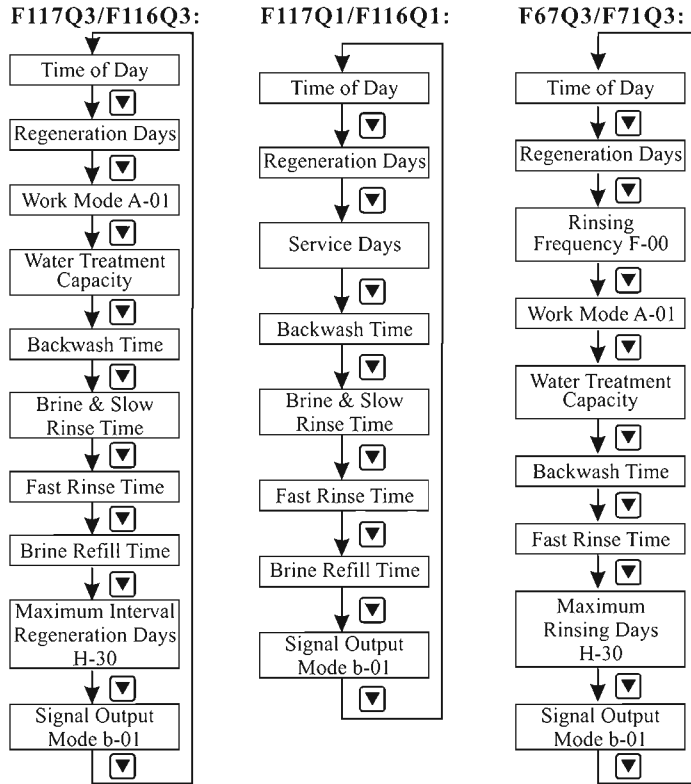



















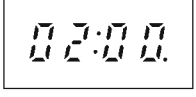



















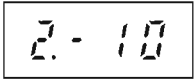





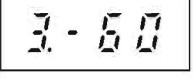





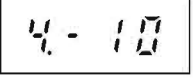

#### B. Parameter Setting

In program inquiry mode, press “☐” and enter into program set mode. Press “▼” or “▲” can adjust the value.



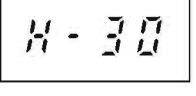

#### C. The steps of parameter setting (Take F117Q3 A-01 for Example)

Item	Process Steps	Symbol
Time of Day	1. In time of day display status, Press “☐” to enter program set mode, both hour value and “:” flash, press “▼” or “▲” to adjust the hour value; 2. Press “☐” again, both minute value and “:” flash, press “▼” or “▲” to adjust the minute value; 3. Press “☐”, finish adjustment, press “⏏” to return.	







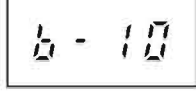

MODEL: F67Q/F71Q/F68Q/F69Q/F116Q/F117Q

Regeneration Time	1. In regeneration time viewing status, press “  ” and enter into program set mode. Regeneration hour value flashes, press “  ” or “  ” to adjust the hour value (“:” lights on); 2. Press “  ” again, regeneration minute flashes, press “  ” or “  ” to adjust the minute value (“:” lights on); 3. Press “  ” to finish adjustment, press “  ” to return.	
Control Mode	1. In control mode viewing status, press “  ” to enter program set mode. Control mode A-01 flashes, press “  ” or “  ” to adjust the working mode; 2. Press “  ” to finish adjustment, press “  ” to return.	
Water Treatment Capacity	1. In water treatment capacity viewing status, press “  ” and enter program set mode. Water treatment capacity value flashes, press “  ” or “  ” to adjust the valve; 2. Press “  ” again, water treatment capacity decimal flashes, press “  ” or “  ” to adjust the decimal value; 3. Press “  ” to finish adjustment, press “  ” to return.	
Backwash Time	1. In backwash viewing status, press “  ” and enter program set mode. Backwash time value flashes, press “  ” or “  ” to adjust the backwash time 2. Press “  ” to finish adjustment, press “  ” to return.	
Brine & Slow Rinse Time	1. In brine & slow rinse time viewing status, press “  ” and enter program set mode. Brine & slow rinse time value flashes, press “  ” or “  ” to adjust the brine & slow rinse time; 2. Press “  ” to finish adjustment, press “  ” to return.	
Fast Rinse Time	1. In fast rinse time viewing status, press “  ” and enter program set mode. Fast rinse time value flashes, press “  ” or “  ” to adjust the fast rinse time; 2. Press “  ” to finish adjustment, press “  ” to return.	
Brine Refill Time	1. In brine refill time viewing status, press “  ” and enter program set mode. Brine refill time value flashes, press “  ” or “  ” to adjust the brine refill time 2. Press “  ” to finish adjustment, press “  ” to return.	
Maximum Interval Regeneration Days	1. In maximum interval regeneration days viewing status, press “  ” and enter program set mode. Maximum interval regeneration days value flashes, press “  ” or “  ” to adjust the maximum interval regeneration days; 2. Press “  ” to finish adjustment, press “  ” to return.	

MODEL: F67Q/F71Q/F68Q/F69Q/F116Q/F117Q



Signal Output Mode	1. In signal output mode viewing status, press “  ” and enter program set mode. Signal output mode value flashes, press “  ” or “  ” to adjust the signal output mode; 2. Press “  ” to finish adjustment, press “  ” to return.	
--------------------	--	---

For example, a softener has set fast rinse time as 12 minutes. After regenerating, the chloridion in the outlet water is always higher than normal, which indicates that the fast rinse time is too short. If you want to set the time as 15 minutes, the modification steps as follows:

- ① Press and hold both “” and “” to unlock the button (The fourth decimal point of digital tube lights off);
- ② Press “”, the third decimal point of digital tube lights on;
- ③ Press “” or “” continuously until in service status, the digital display area shows: 4-12M;
- ④ Press “”, 12 flashes;
- ⑤ Press “” continuously until 12 change to 15;
- ⑥ Press “” again and hear a sound “Di”, the frame stop flickering, the program returns to enquiry status;
- ⑦ If you want to adjust other parameters, you can adjust as above 3-5 steps; if not, press “” to exit the program inquiry status. The display are shows the current working status.

**3.6 Trial Running**

After installing the multi-functional flow control valve on the resin tank with the connected pipes, as well as setting up the relevant parameters, please conduct the trail running as follows:

- A. Close inlet/outlet valve B and Valve C, open bypass valve A, clean the impurity in the pipe, and then close bypass valve A (as Figure 1-3).
- B. Add calculated-volume water to the brine tank and adjust the air check valve. Add solid particle salt to the brine tank then dissolve the salt as much as possible.
- C. Power on. Press “” and enter Backwash status, 2-lights on, slowly open the inlet valve B to 1/4 position, making the water flows into the resin tank; you can hear the sound of air-out from the drain pipeline. After air totally emptied, then open inlet valve B completely and clean the impurity in the resin tank until the outlet water is clean. It will take 8~10 minutes to finish the whole process.
- D. Press “”, finish the Backwash status, and control valve ente into Brine & Slow Rinse. 3-lights on, enter into the process of Brine & Slow Rinse. The air check valve closed when control valve finished brine drawing, then slow rinse starts to work. It is about 60~65 minutes for whole process.

MODEL: F67Q/F71Q/F68Q/F69Q/F116Q/F117Q

E. Press “

F. Press “

G.Press “

**Note:**

● When the control valve enters into the regeneration status, all programs can be finished automatically according to the setting time; if you want one of steps to be terminated early, you can press “

● If water inflows too fast, the media in tank will be damaged. When water inflows slowly, there is a sound of air emptying from drain pipeline.

● After changing resin, please empty air in the resin according to above step C.

● In the process of trial running, please check the water situation in all positions, and ensure there is no resin leakage.

● The time of Backwash, Brine & Slow Rinse, Fast Rinse and Brine Refill status can be set and executed according to the calculation in the formula or suggested from the control valve suppliers.

MODEL: F67Q/F71Q/F68Q/F69Q/F116Q/F117Q

**3.7 Trouble-Shooting**

**A. Control Valve Fault**

Problem	Cause	Correction
1. Softener fails to regenerate.	A.Electrical service to unit has been interrupted. B.Regeneration cycles set incorrect. C.Controller is defective. D.Motor fails to work.	A. Assure permanent electrical service (Check fuse, plug, pull chain or switch). B. Reset regeneration cycles. C. Replace controller. D. Replace motor.
2. Regeneration time is not correct.	A.Time of Day does not set correctly. B.Power failure more than 3 days.	A. Check program and reset time of day. B. Reset the time of day
3. Softener supply hard water.	A.Bypass valve is open or leaking. B.No salt in brine tank. C.Injector is plugged. D.Insufficient water flows into brine tank. E.O-ring on riser pipe leaks. F.Internal valve leaks. G.Regeneration cycles are not correct or deterioration of water quality H.Shortage of resin. I.Bad quality of raw water or turbine is blocked.	A. Close or repair bypass valve. B. Make sure there is solid salt in the brine tank. C. Change or clean injector. D. Check brine tank refill time. E. Make sure riser pipe and O-ring are not cracked. F. Repair or replace valve body. G. Set correct regeneration cycles in the program. H. Add resin to mineral tank and check the reason of resin leaks. I. Reduce the inlet turbidity, clean or replace turbine.
4. Softener fails to draw brine.	A.Inlet line pressure is too low. B.Brine line is blocked. C.Brine line is leaking. D.Injector is blocked or damaged. E.Internal control leaks. F.Drain line is plugged. G.Sizes of injector and DLFC are not matched with tank.	A. Increase inlet line pressure. B. Clean brine line. C. Check brine line. D. Clean or replace injector. E. Repair or replace valve body. F. Check the drain line pipe. G. Select correct injector size and DLFC according to user manual.
5. Unit used too much salt.	A.Improper salt setting. B.Excessive water in brine tank.	A. Setting the appropriate amount of salt for primary regeneration. B. See problem No.6.
6. Excessive water in brine tank or overfall.	A.Overlong refilling time. B.Remain too much water after brine. C.Foreign material in brine valve. D.Not install safety brine valve but power failure while salting. E.Safety brine valve breakdown.	A. Reset correct refilling time. B. Check the injector and make sure no stuff in the brine pipe. C. Clean brine valve and brine line. D. Stop water supplying and restart or install safety brine valve in salt tank. E. Repair or replace safety brine valve.

Control Valve Fault (Continue)

7. Pressure lost or rust in pipe line	A. Iron in the water supply pipe. B. Iron mass in the softener. C. Fouled resin bed. D. Too much iron in the raw water.	A. Clean the water supply pipe. B. Clean valve and add resin cleaning chemical, increase frequency of regeneration. C. Check backwash, brine and brine tank refill. Increase frequency of regeneration and backwash time. D. Iron removal equipment is required to install before softening.
8. Loss of resin through drain line.	A. Air in water system. B. Strainer broken. C. Improperly sized drain line control.	A. Assure that well system has proper air eliminator control. B. Replace new strainer. C. Check for proper drain rate.
9. Control cycle continuously.	A. Controller is faulty. B. Time of regeneration steps were set to zero.	A. Replace controller. B. Check program setting and reset.
10. Drain flows continuously.	A. Internal valve leak. B. Power off when in back wash or fast rinse.	A. Check and repair valve body or replace it. B. Adjust valve to service position by manual or turn off bypass valve and restart when electricity supply.
11. Interrupted or irregular brine.	A. Water pressure is too low or not stable. B. Injector is blocked or faulty. C. Air in resin tank. D. Floccules in resin tank during up-flow regeneration.	A. Increase water pressure to request. B. Clean or replace injector. C. Check and find the reason. D. Clean the floccules in resin tank.
12. Water flows out from drain or brine pipe after regeneration.	A. Foreign material in valve which makes valve can't be closed completely. B. Hard water mixed in valve body. C. Water pressure is too high which results in valve not getting the right status. D. When in backwash status, drain line is communicated with brine line.	A. Clean foreign material in valve body. B. Change valve core or sealing ring. C. Reduce water pressure or use pressure release function. D. Add check valve or solenoid valve in the outlet, or liquid level controller in the brine tank.
13. Salt water in outflow pipe.	A. Foreign material in injector or injector fails to work. B. Brine valve can't be shut-off. C. Time of fast rinse too short.	A. Clean and repair injector. B. Repair brine valve and clean it. C. Extend fast rinse time.
14. Circle capacity decreases.	A. Regenerate not properly. B. Fouled resin bed or polluted. C. Salt setting is not proper. D. Softener setting is not proper. E. Raw water quality deteriorated. F. Turbine has already gotten stuck.	A. Regenerate according to right way. B. Increase backwash flow rate and time, clean or change resin. C. Readjust brine drawing time. D. According to the test of outlet water, recount and reset. E. Regenerate unit by manual temporary then reset regeneration cycle. F. Disassemble flow meter and clean it or replace a new flow meter.

B. Controller Fault

Problem	Cause	Correction
1. All indicators display on front panel.	A. Control board is faulty. B. Transformer damaged. C. Electrical service is not stable.	A. Replace control board. B. Check and replace transformer. C. Check and adjust electrical service.
2. No display on front panel.	A. Wiring of control board with transformer fails to work. B. Control board damaged. C. Transformer damaged. D. Electrical service is off.	A. Check and replace wiring. B. Replace control board. C. Replace transformer. D. Check electricity.
3. Show E1	A. Wiring of locating board with control board fails to work. B. Locating board damaged. C. Motor gear and big gear damaged. D. Control board damaged. E. Wiring of motor with control board is fault. F. Motor damaged. G. Set wrong model.	A. Replace wiring. B. Replace locating board. C. Replace motor gear and big gear. D. Replace control board. E. Replace wiring. F. Replace motor. G. Reset power
4. Show E3 or E4	A. Control board is faulty.	A. Replace control board.

3.8 Assembly & Parts

Flow Meter Connector & Animated Connector

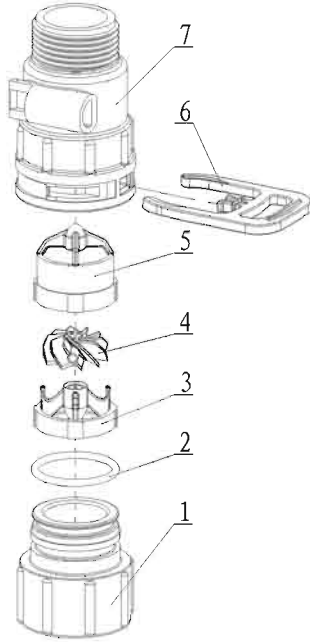

5447018 Flow Meter

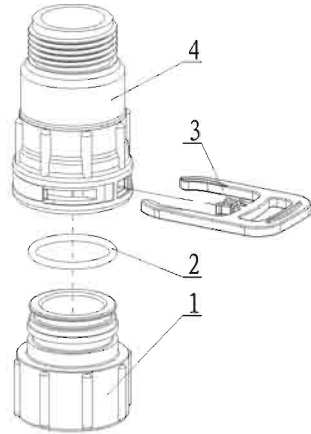

5457002 Animated Connector

5447018 Flow Meter				5457002 Animated Connector			
Item No.	Description	Part No.	Quantity	Item No.	Description	Part No.	Quantity
1	Animated Nut	8945001	1	1	Animated Nut	8945001	1
2	O-ring	8378081	1	2	O-ring	8378081	1
3	Impeller supporter	5115022	1	3	Clip	8270004	1
4	Impeller	5436010	1	4	Connector	8458038	1
5	Impeller supporter	5115021	1				
6	Clip	8270004	1				
7	Shell	8002001	1				

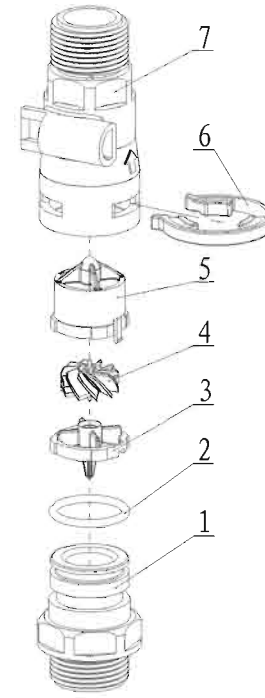

5447020 Flow Meter

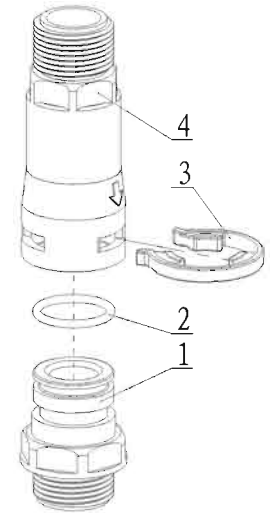

5457003 Animated Connector

5447020 Flow Meter				5457003 Animated Connector			
Item No.	Description	Part No.	Quantity	Item No.	Description	Part No.	Quantity
1	Connector	8458014	1	1	Connector	8458014	1
2	O-ring	8378064	1	2	O-ring	8378064	1
3	Impeller supporter	5115023	1	3	Clip	8270005	1
4	Impeller	5436013	1	4	Connector	8458039	1
5	Impeller supporter	5115024	1				
6	Clip	8270005	1				
7	Shell	8002006	1				

MODEL: F67Q/F71Q/F68Q/F69Q/F116Q/F117Q

Construction figure of F67Q3:

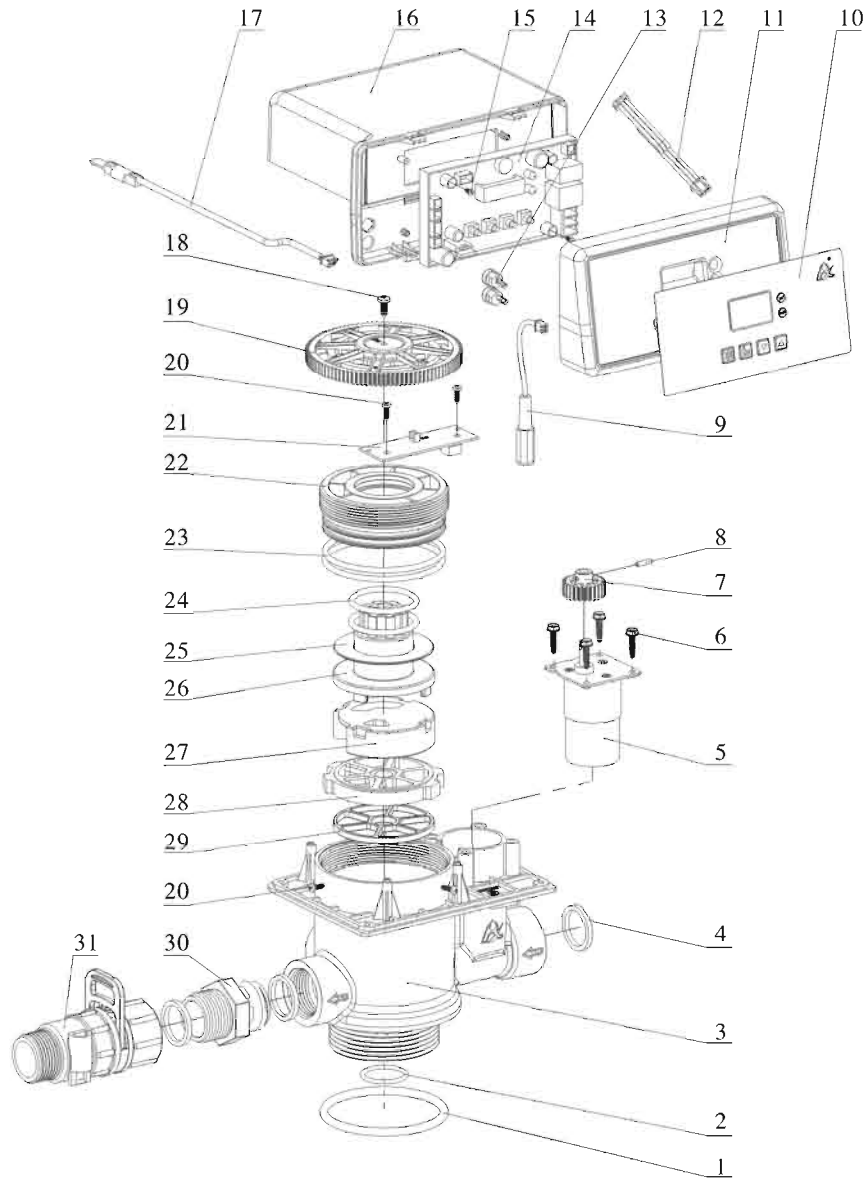

MODEL: F67Q/F71Q/F68Q/F69Q/F116Q/F117Q

F67Q3 Valve Body Components and No. [F67Q1 doesn't have No.17, 30 and 31, and change No. 10 from 8865174 (630) to 8865175 (631)]

Item No.	Description	Part No.	Quantity	Item No.	Description	Part No.	Quantity
1	O-ring 73×5.3	8378143	1	16	Dust Cover	8005091	1
2	O-ring 25.8×2.65	8378078	1	17	Probe Wire	6386014	1
3	Valve Body (ABS+GF10)	8022039	1	18	Screw, Cross ST3.9×13	8909013	1
	Valve Body (PPO+GF20)	8022040		19	Gear	8241034	1
4	Seal Ring	8371001	4	20	Screw, Cross ST2.9×16	8909008	2
5	Motor	6158021	1	21	Locating Board	6380032	1
6	Screw, Cross ST3.9×16	8909016	4	22	Fitting Nut	8092004	1
7	Small Gear	8241003	1	23	O-ring 73×3.55	8378128	2
8	Pin	8993003	1	24	O-ring 38.7×3.55	8378184	2
9	Wire for Power	5513001	1	25	Anti-friction Washer	8216004	1
10	Label	8865175 (631)	1	26	Shaft	8258004	1
11	Front Cover	8300060	1	27	Moving Disk	8459014	1
12	Wire for Locating Board	5511021	1	28	Fixed Disk	8469013	1
13	Cable Clip	8126004	2	29	Seal Ring	8370027	1
14	Control Board	6382159	1	30	Connector	8458205	1
15	Screw, Cross ST2.2×6.5	8909004	2	31	Flow Meter	5447018	1

MODEL: F67Q/F71Q/F68Q/F69Q/F116Q/F117Q

Construction figure of F68Q3:

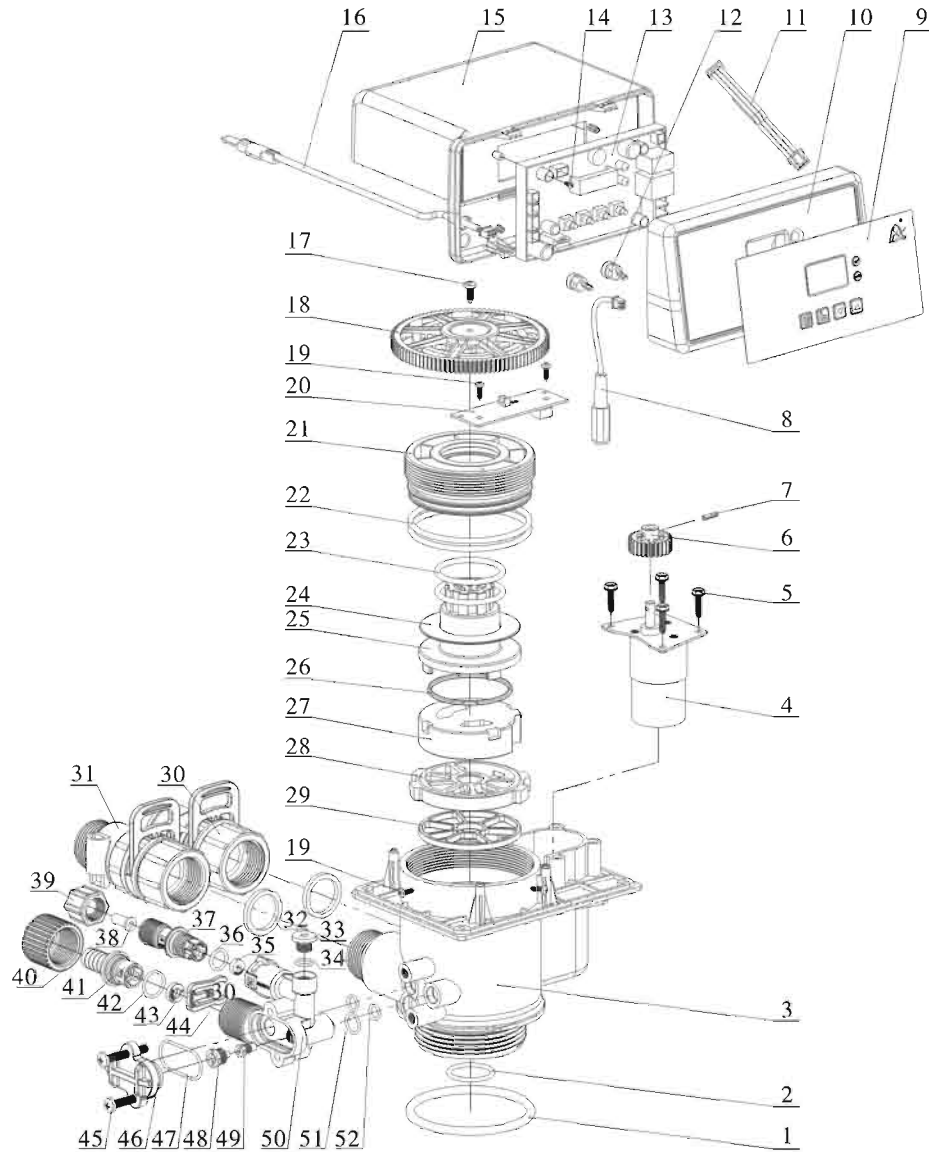

MODEL: F67Q/F71Q/F68Q/F69Q/F116Q/F117Q

F68Q3 Valve Body Components and No. [F68Q1 doesn't have No.16, 30 and 31, and change No. 9 from 8865174 (630) to 8865175 (631)]

Item No.	Description	Part No.	Quantity	Item No.	Description	Part No.	Quantity
1	O-ring 73×5.3	8378143	1	27	Moving Disk	8459078	1
2	O-ring 25.8×2.65	8378078	1	28	Fixed Disk	8469079	1
3	Valve Body (ABS+GF10)	5022022	1	29	Seal Ring	8370111	1
	Valve Body (PPO+GF20)	5022023		30	Animated Connector	5457002	1
4	Motor	6158011	1	31	Flow Meter	5447018	1
5	Screw, Cross ST3.9×16	8909016	4	32	Seal Ring	8371001	2
6	Small Gear	8241003	1	33	Plug	8323002	1
7	Pin	8993003	1	34	Seal Ring	8370003	1
8	Wire for Power	5513001	1	35	BLFC	8468055	1
9	Label	8865175 (631)	1	36	O-ring 11×2	8378169	1
10	Front Cover	8300060	1	37	Connector	8458068	1
11	Wire for Locating Board	5511021	1	38	Tube	8457004	1
12	Cable Clip	8126004	2	39	Hex Nut	8940001	1
13	Control Board	6382159	1	40	Animated Nut	8945025	1
14	Screw, Cross ST2.2×6.5	8909004	2	41	Connector	8458064	1
15	Dust Cover	8005091	1	42	O-ring 15×1.8	8378179	1
16	Probe Wire	6386014	1	43	DLFC	Without this part	1
17	Screw, Cross ST3.9×13	8909013	1	44	Clip	8270010	1
18	Gear	8241053	1	45	Screw, Cross M5×35	8902017	2
19	Screw, Cross ST2.9×16	8909008	2	46	Cover of Injector	8315001	1
20	Locating Board	6380032	1	47	O-ring 30×1.8	8378025	1
21	Fitting Nut	8092004	1	48	Nozzle, Injector	8454008	1
22	O-ring 73×3.55	8378128	2	49	Throat, Injector	8467008	1
23	O-ring 38.7×3.55	8378184	2	50	Injector Body	8008010	1
24	Anti-friction Washer	8216004	1	51	O-ring 10.82×1.78	8378012	1
25	Shaft	8258004	1	52	O-ring 7.5×1.8	8378016	2
26	Moving Seal Ring	8370001	1				



MODEL: F67Q/F71Q/F68Q/F69Q/F116Q/F117Q

Construction figure of F69Q3:

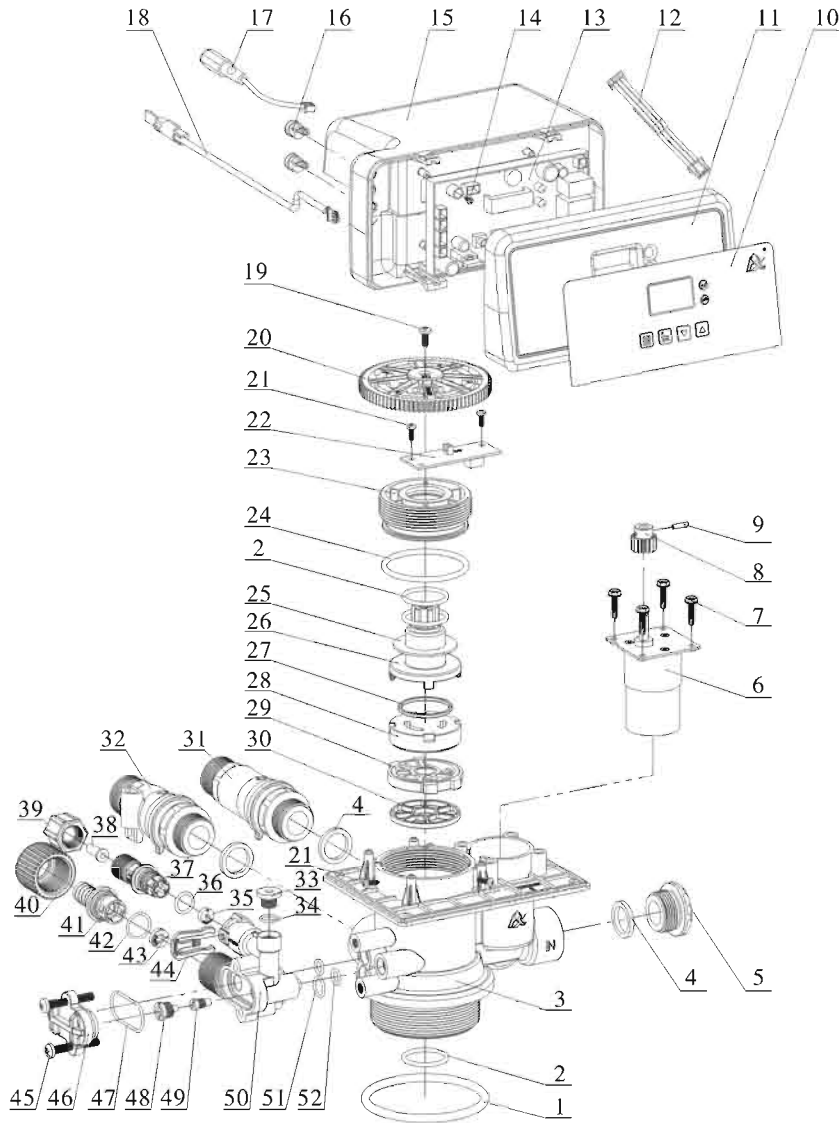

MODEL: F67Q/F71Q/F68Q/F69Q/F116Q/F117Q

F69Q3 Valve Body Components and No. [F69Q1 doesn't have No.18, 31 and 32, and change No. 10 from 8865176 (632) to 8865177 (633)]

Item No.	Description	Part No.	Quantity	Item No.	Description	Part No.	Quantity
1	O-ring 73×5.3	8378143	1	27	Moving Seal Ring	8370053	1
2	O-ring 25.8×2.65	8378078	1	28	Moving Disk	8459016	1
3	Valve Body (ABS+GF10)	5022024	1	29	Fixed Disk	8469015	1
	Valve Body (PPO+GF20)	5022025		30	Seal Ring	8370034	1
4	Seal Ring	8371019	3	31	Animated Connector	5457003	1
5	Plug	8323005	1	32	Flow Meter	5447020	1
6	Motor	6158006	1	33	Plug	8323002	1
7	Screw, Cross ST3.9×16	8909016	4	34	Seal Ring	8370003	1
8	Small Gear	8241010	1	35	BLFC	8468053	1
9	Pin	8993003	1	36	O-ring 11×2	8378169	1
10	Label	8865177 (633)	1	37	Connector	8458068	1
11	Front Cover	8300059	1	38	Tube	8457004	1
12	Wire for Locating Board	5511021	1	39	Hex Nut	8940001	1
13	Control Board	6382159	1	40	Animated Nut	8945025	1
14	Screw, Cross ST2.2×6.5	8909004	2	41	Connector	8458064	1
15	Dust Cover	8005005	1	42	O-ring 15×1.8	8378179	1
16	Cable Clip	8126004	2	43	DLFC	8468077	1
17	Wire for Power	5513001	1	44	Clip	8270010	1
18	Probe Wire	6386014	1	45	Screw, Cross M5×35	8902017	2
19	Screw, Cross ST3.9×13	8909013	1	46	Cover of Injector	8315001	1
20	Gear	8241053	1	47	O-ring 30×1.8	8378025	1
21	Screw, Cross ST2.9×16	8909008	5	48	Nozzle, Injector	8454004	1
22	Locating Board	6380033	1	49	Throat, Injector	8467004	1
23	Fitting Nut	8092007	1	50	Injector Body	8008010	1
24	O-ring 50.39×3.53	8378107	1	51	O-ring 10.82×1.78	8378012	1
25	Anti-friction Washer	8216010	1	52	O-ring 7.5×1.8	8378016	2
26	Shaft	8258009	1				

MODEL: F67Q/F71Q/F68Q/F69Q/F116Q/F117Q

Construction figure of F71Q3:

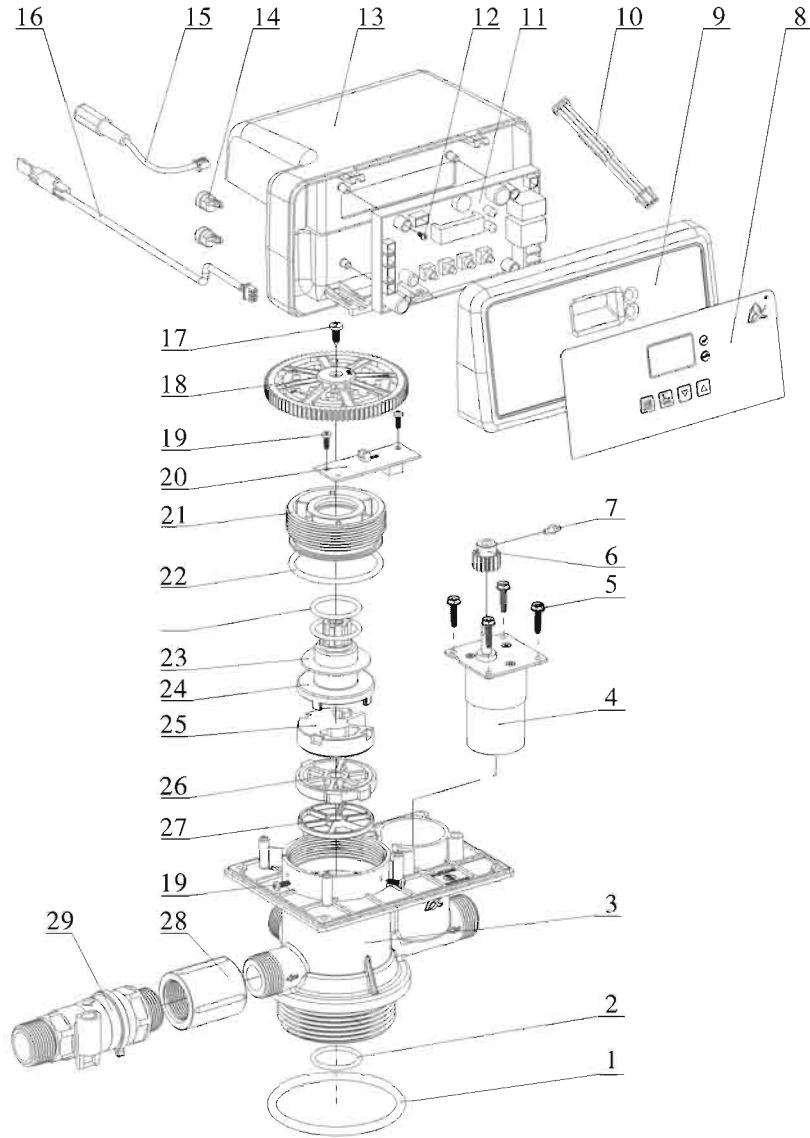

MODEL: F67Q/F71Q/F68Q/F69Q/F116Q/F117Q

F71Q3 Valve Body Components and No. [F71Q1 doesn't have No.16, 28 and 29, and change No. 8 from 8865176 (632) to 8865177 (633)]

Item No.	Description	Part No.	Quantity	Item No.	Description	Part No.	Quantity
1	O-ring 73×5.3	8378143	1	15	Wire for Power	5513001	1
2	O-ring 25.8×2.65	8378078	1	16	Probe Wire	6386014	1
3	Valve Body (ABS+GF10)	8022048	1	17	Screw, Cross ST3.9×13	8909013	1
	Valve Body (PPO+GF20)	8022049		18	Gear	8241038	1
4	Motor	6158006	1	19	Screw, Cross ST2.9×9.5	8909008	5
5	Screw, Cross ST3.9×16	8909016	4	20	Locating Board	6380033	1
6	Small Gear	8241010	1	21	Fitting Nut	8092007	1
7	Pin	8993003	1	22	O-ring 50.39×3.53	8378107	1
8	Label	8865177 (633)	1	23	Anti-friction Washer	8216010	1
9	Front Cover	8300059	1	24	Shaft	8258009	1
10	Wire for Locating Board	5511021	1	25	Moving Disk	8459019	1
11	Control Board	6382159	1	26	Fixed Disk	8469018	1
12	Screw, Cross ST2.2×6.5	8909004	2	27	Seal Ring	8370038	1
13	Dust Cover	8005005	1	28	Connector	8458206	1
14	Cable Clip	8126004	2	29	Flow Meter	5447020	1

MODEL: F67Q/F71Q/F68Q/F69Q/F116Q/F117Q

Construction figure of F116Q3:

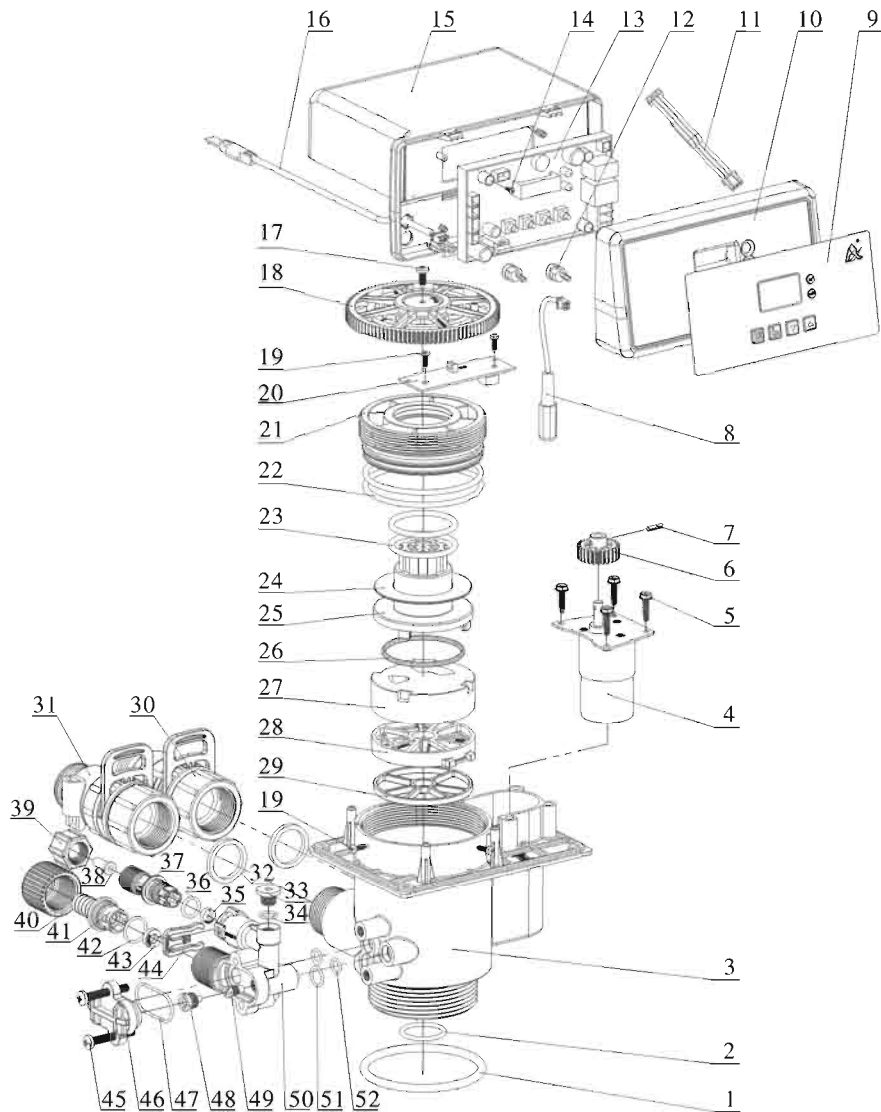

MODEL: F67Q/F71Q/F68Q/F69Q/F116Q/F117Q

F116Q3 Valve Body Components and No. [F116Q1 doesn't have No.16, 30 and 31, and change No. 9 from 8865174 (630) to 8865175 (631)]

Item No.	Description	Part No.	Quantity	Item No.	Description	Part No.	Quantity
1	O-ring 73×5.3	8378143	1	27	Moving Disk	8459078	1
2	O-ring 25.8×2.65	8378078	1	28	Fixed Disk	8469079	1
3	Valve Body (ABS+GF10)	5022104	1	29	Seal Ring	8370111	1
	Valve Body (PPO+GF20)	5022105		30	Animated Connector	5457002	1
4	Motor	6158073	1	31	Flow Meter	5447018	1
5	Screw, Cross ST3.9×16	8909016	4	32	Seal Ring	8371001	2
6	Small Gear	8241003	1	33	Plug	8323002	1
7	Pin	8993003	1	34	Seal Ring	8370003	1
8	Wire for Power	5513001	1	35	BLFC	8468055	1
9	Label	8865175 (631)	1	36	O-ring 11×2	8378169	1
10	Front Cover	8300060	1	37	Connector	8458068	1
11	Wire for Locating Board	5511021	1	38	Tube	8457004	1
12	Cable Clip	8126004	2	39	Hex Nut	8940001	1
13	Control Board	6382159	1	40	Animated Nut	8945025	1
14	Screw, Cross ST2.2×6.5	8909004	2	41	Connector	8458064	1
15	Dust Cover	8005091	1	42	O-ring 15×1.8	8378179	1
16	Probe Wire	6386014	1	43	DLFC	Without this part	1
17	Screw, Cross ST3.9×13	8909013	1	44	Clip	8270010	1
18	Gear	8241053	1	45	Screw, Cross M5×35	8902017	2
19	Screw, Cross ST2.9×16	8909008	2	46	Cover of Injector	8315001	1
20	Locating Board	6380032	1	47	O-ring 30×1.8	8378025	1
21	Fitting Nut	8092004	1	48	Nozzle, Injector	8454009	1
22	O-ring 73×3.55	8378128	2	49	Throat, Injector	8467009	1
23	O-ring 38.7×3.55	8378184	2	50	Injector Body	8008010	1
24	Anti-friction Washer	8216004	1	51	O-ring 10.82×1.78	8378012	1
25	Shaft	8258004	1	52	O-ring 7.5×1.8	8378016	2
26	Moving Seal Ring	8370001	1				

MODEL: F67Q/F71Q/F68Q/F69Q/F116Q/F117Q

Construction figure of F117Q3:

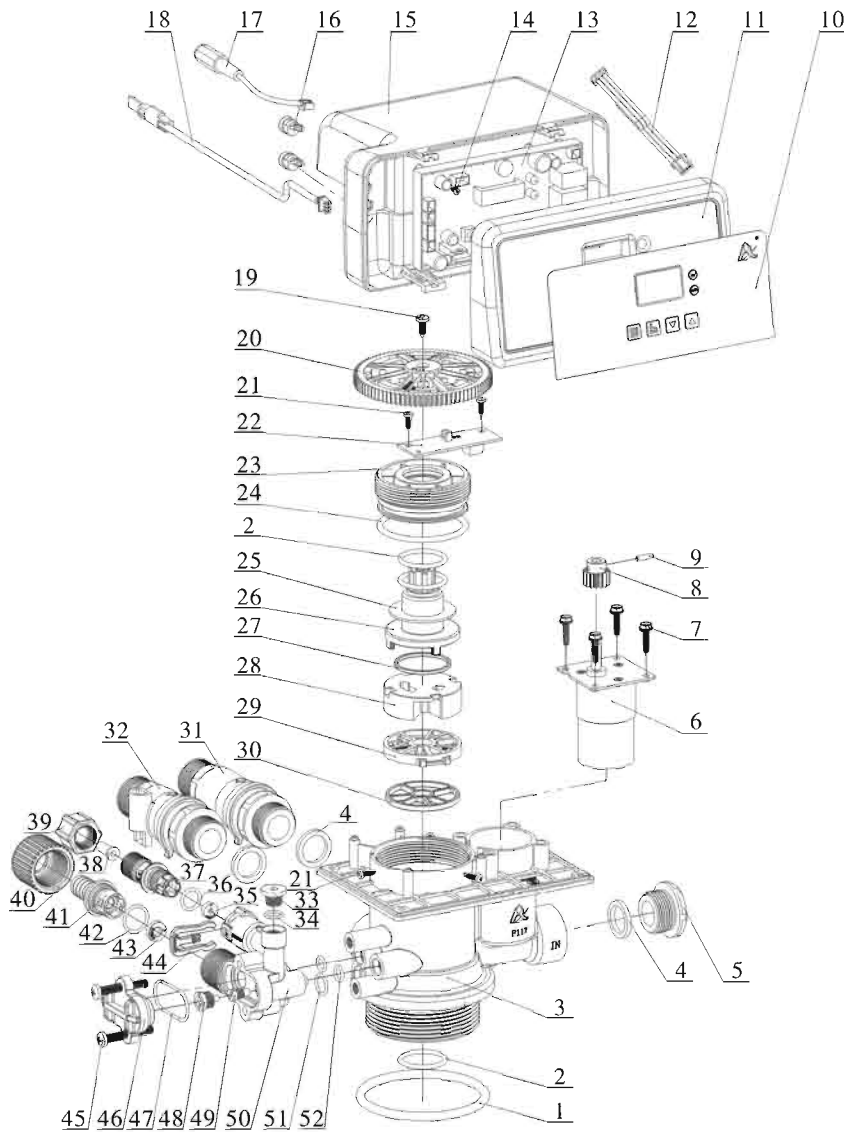

MODEL: F67Q/F71Q/F68Q/F69Q/F116Q/F117Q

F117Q3 Valve Body Components and No. [F117Q1 doesn't have No.18, 31 and 32, and change No. 10 from 8865176 (632) to 8865177 (633)]

Item No.	Description	Part No.	Quantity	Item No.	Description	Part No.	Quantity
1	O-ring 73×5.3	8378143	1	27	Moving Seal Ring	8370053	1
2	O-ring 25.8×2.65	8378078	1	28	Moving Disk	8459079	1
3	Valve Body (ABS+GF10)	5022106	1	29	Fixed Disk	8469080	1
	Valve Body (PPO+GF20)	5022107		30	Seal Ring	8370112	1
4	Seal Ring	8371019	3	31	Animated Connector	5457003	1
5	Plug	8323005	1	32	Flow Meter	5447020	1
6	Motor	6158006	1	33	Plug	8323002	1
7	Screw, Cross ST3.9×16	8909016	4	34	Seal Ring	8370003	1
8	Small Gear	8241010	1	35	BLFC	8468055	1
9	Pin	8993003	1	36	O-ring 11×2	8378169	1
10	Label	8865177 (633)	1	37	Connector	8458068	1
11	Front Cover	8300059	1	38	Tube	8457004	1
12	Wire for Locating Board	5511021	1	39	Hex Nut	8940001	1
13	Control Board	6382159	1	40	Animated Nut	8945025	1
14	Screw, Cross ST2.2×6.5	8909004	2	41	Connector	8458064	1
15	Dust Cover	8005005	1	42	O-ring 15×1.8	8378179	1
16	Cable Clip	8126004	2	43	DLFC	8468062	1
17	Wire for Power	5513001	1	44	Clip	8270010	1
18	Probe Wire	6386014	1	45	Screw, Cross M5×35	8902017	2
19	Screw, Cross ST3.9×13	8909013	1	46	Cover of Injector	8315001	1
20	Gear	8241053	1	47	O-ring 30×1.8	8378025	1
21	Screw, Cross ST2.9×9.5	8909008	5	48	Nozzle, Injector	8454007	1
22	Locating Board	6380033	1	49	Throat, Injector	8467007	1
23	Fitting Nut	8092007	1	50	Injector Body	8008010	1
24	O-ring 50.39×3.53	8378107	1	51	O-ring 10.82×1.78	8378012	1
25	Anti-friction Washer	8216010	1	52	O-ring 7.5×1.8	8378016	2
26	Shaft	8258009	1				

#### 4. Warranty Card

Dear client:

This warranty card is the guarantee proof of Runxin brand multi-functional flow control valve. It is kept by client self. You could get the after-sales services from the supplier which is appointed by Runxin manufacturer. Please keep it properly. It couldn't be retrieved if lost. It couldn't be repaired free of charge under the below conditions:

1. Guarantee period expired. (One year)
2. Damage resulting from using, maintenance, and keeping that are not in accordance with the instruction.
3. Damage resulting from repairing not by the appointed maintenance personnel.
4. Content in guarantee proof is unconfirmed with the label on the real good or be altered.
5. Damage resulting from force majeure.

Product Name	 Multi-functional Flow Control Valve for Water Treatment Systems			
Model			Code of Valve Body	
Purchase Company Name			Tel/Cel.	
Problem				
Solution				
Date of Repairing		Date of Examination		Maintenance Man Signature

When product needs warranty service, please contact with your direct supplier first, after got permission, then fill in the below content and send this card together with the product to the appointed suppliers or Runxin company.

End-user Company Name			Tel/Cel.	
Purchase Company Name			Tel/Cel.	
Model	Code of Valve Body			
Tank Size $\phi$ ×	Resin Tank Size L	Raw Water Hardness mmol/L		
Water Source: Ground-water <input type="checkbox"/> Tap Water <input type="checkbox"/>	Water Treatment Capacity m <sup>3</sup>	Backwash Time min		
Brine & Slow Rinse Time min	Brine Refill Time min	Fast Rinse Time min		
Problem Description				